

# RECLAMATION

*Managing Water in the West*

## GUIDELINES FOR ROPE ACCESS



2004

# RECLAMATION

*Managing Water in the West*

## Guidelines for Rope Access Work



Technical Service Center  
Denver, Colorado

2004

## **Department of the Interior Mission Statement**

The Mission of the Department of the Interior is to protect and provide access to our Nation's natural and cultural heritage and honor our trust responsibilities to Indian Tribes and our commitments to island communities.

---

## **Bureau of Reclamation Mission Statement**

The mission of the Bureau of Reclamation is to manage, develop, and protect water and related resources in an environmentally and economically sound manner in the interest of the American public.

## **PREFACE**

These guidelines were developed in 2002-2004 for updating and standardizing the techniques, safety practices, and to some extent, the equipment used by Bureau of Reclamation when performing tasks that require the use of rope to access the work site. In 1996-1997, the first edition of the **Bureau of Reclamation Safety Guidelines for Rope-Supported Work** was developed. Since that time, the field of rope access has progressed rapidly. These guidelines attempt to present a thoughtful and updated version of the earlier work.

In 2002, a revision of the **Reclamation Safety and Health Standards (RSHS)**, section 16.2 Rope Supported Safety Requirements was adopted. The requirements in that revision set new standards for equipment, techniques, and personnel qualifications to perform work on rope. In developing these guidelines, the authors have endeavored to define a rope-access system that conforms to section 16.2 of the Standards, while presenting the best thinking in safety and techniques.

In accordance with the RSHS, Reclamation established a Rope Access Safety Board in 2002. The Board was created to establish Reclamation-wide procedures and requirements which will ensure oversight and operational coordination for all rope-access work operations. The Board is establishing an active rope-access safety program which specifies administration, safety guidance, and oversight to conduct all rope-access operations in a safe and uniform manner. A rope-access work policy will be implemented Reclamation-wide upon signature and issuance by the Designated Agency Safety and Health Official.

## **ACKNOWLEDGEMENTS**

These guidelines have been written and edited in large part due to the exhaustive efforts of Mr. Jan Holan of Ropeworks Industrial Corporation. Mr. Holan's dedication to the rope-access industry and safety of the government workforce has literally made this document possible. Mr. Holan has invested countless hours of both his own and his company's time to produce a document dedicated to improving rope access at Reclamation.

The authors also wish to acknowledge the help of Mr. Alan Forrest of North Sea Lifting Ltd. for his contributions of many of the graphics contained in these guidelines. Petzl America also made significant contributions of graphics that did not exist elsewhere in the industry. Mr. Michel Goulet of Petzl provided technical input and review of the high-line discussions based on his extensive background in the rescue field. Mr. James Frank, president of CMC Rescue also provided valuable input and review of the high-line sections based on his decades of experience in the team-rescue field.

The authors also wish to acknowledge the contribution to rope access in the Bureau of Reclamation by Mr. Albert Graves of the Lower Colorado Region. Mr. Graves provided much of the impetus to establish rope access as a safe and viable work method for Reclamation. Mr. Graves' continued support and his input to this document have been invaluable.

This document has been compiled by the members of the Yucca Mountain Mapping Group in Las Vegas, Nevada. Ms. Jean Higgins and Mr. Mark Morton have contributed long hours to helping with the production of these guidelines.

Introduction



Definitions



The Rope-Access Team



Standard Procedures



Equipment



Knots & Hitches



Anchors



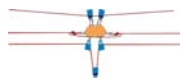
System Analysis



Rope-Access Technique



Load and Tool Management



Rescue Protocol



Appendices 1 – 4



## Chapter 1. Introduction

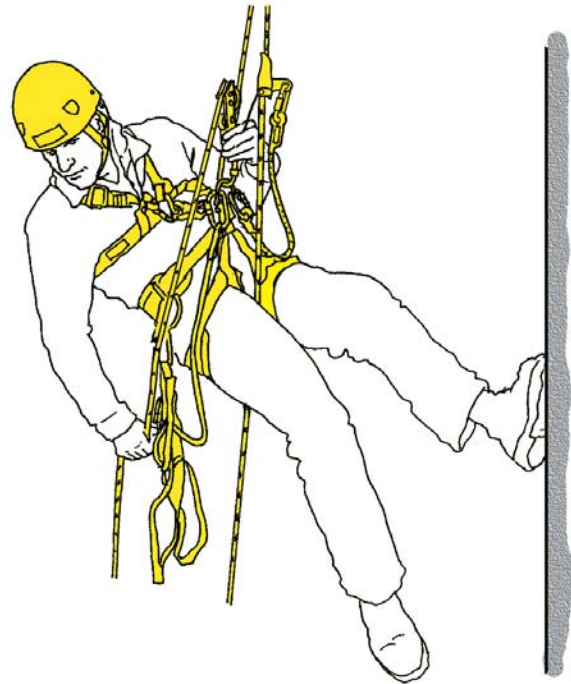
The purpose of these guidelines is to establish minimum acceptable standards for personnel, procedures, equipment, and conditions for conducting rope-access activities.

**Rope access** is a system of techniques by which access is gained to structures, geologic features, or locations where ropes are the primary means of support, positioning, and fall protection.

In rope access (Figure 1-1), the worker relies primarily, or solely on the rope for his/her means of ascending, descending and traversing. Appropriate standards, documentation, training, equipment, and supervision are essential for maintaining a safe rope-access program.

The goal of these guidelines is to establish rope-access practices on a Reclamation-wide basis, consistent with national and international standards. Individual safety and organizational risk management is the guiding principle behind this standardization. Providing clear, consistent, and widely-used techniques and practices will help assure that Reclamation's workers and contractors are provided with the safest possible means to perform work in areas where traditional access methods have been difficult, dangerous, or impossible.

These guidelines supplement requirements defined in Reclamation Safety and Health Standard Section **16.2 -Rope Supported Safety Requirements**. These requirements apply to work activities where ropes provide the primary means of access, support, and fall protection.



**Figure 1-1.** Rope-access system

Guidelines are needed *in addition* to the safety requirements to ensure a reasonable degree of safety for personnel involved in rope-supported activity and to assist personnel in the selection of proven techniques and equipment.

These guidelines establish the minimum acceptable practices and procedures for training, personnel and equipment for Reclamation, and contract operations conducted on behalf of Reclamation. Any changes that diminish or reduce these minimum acceptable practices shall be reviewed and found acceptable to the Rope Access Safety Board. The safety of personnel using lesser practices that are not reviewed or accepted by the Board

become the responsibility of that rope-access team leader.

The scope of this document includes safety and self-rescue protocol for rope-access techniques. These techniques are used in various activities including scaling of rock slopes, geologic mapping, instrument installation, structural inspections, installation of geotechnical monitoring stations, rock-slope stabilization, and operations and maintenance.

Work using standard access and fall-arrest systems, hoisting systems, or heavy equipment systems is not discussed. Please refer to the appropriate Reclamation Safety and Health Standards for regulations governing the use of these types of equipment.

Rope-access techniques applicable to industrial repair and maintenance requiring heavy equipment are beyond the scope of this document. The rescue protocol herein is intended for emergency self and team rescue, and is not applicable to professional emergency rescue.

### **Introduction to Working at Height**

Workers in the industrial setting may be required to carry out their duties in areas where traditional access methods may be difficult, dangerous, or impossible. In order to implement a safe and effective working-at-height program, especially one involving rope-access, management must implement the following:

- 1) Standards & Procedures
- 2) Thorough Training
- 3) Proper Equipment
- 4) Qualified Supervision

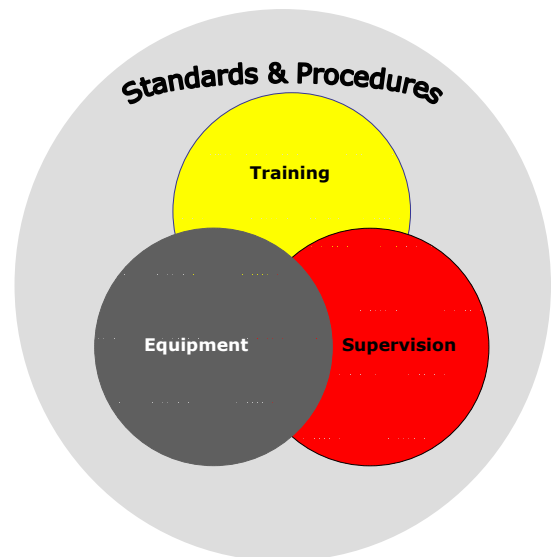
The relationship between these critical components is shown in Figure 1-2.

The challenge to workers and employers alike is to design systems that allow the operatives to access the worksite safely

and efficiently without exposure to unnecessary or unacceptable risk. In other words, personnel working at height must be provided with (1) an effective means of access/support and (2) a safe *fall-protection* system. Working at height therefore involves these components:

### **ACCESS/SUPPORT + FALL PROTECTION**

For each type of access, the type of fall protection varies depending on the appropriate measures that can be safely and practically applied to each work situation. Various types of access are described in the succeeding paragraphs followed by a discussion of the types of fall protection that can be applied. As the worker moves away from engineered platforms, his/her weight is transferred more and more onto personal protective equipment (PPE) and/or ropes, until, in the fully suspended mode, the worker is 100% supported by rope.



**Figure 1-2.** Requirements for implementing a safe work-at-height program.

The method of access and support used by personnel working at height can vary

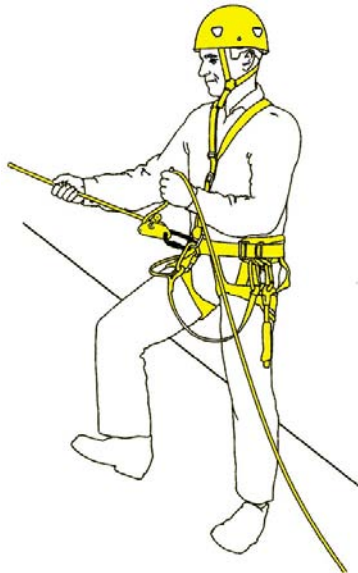


considerably but are generally represented by Figure 1-4.

*Permanent access* such as walkways, ladders, and staging are engineered to restrict the worker to the confines of the designed structure.

*Temporary platforms* such as scaffolding rely on generic design to support the weight of workers. Unprotected ladders are often used as the means of access. When *structure climbing* is used to move about the feature, the primary means of support is still the structure.

*Work positioning* involves work on a slope, structure, or feature where a portion of the worker's weight is supported by the equipment and a portion supported by the structure. Work positioning techniques are useful for working on moderate slopes, towers, and poles.



**Figure 1-3.** Work-positioning system

**Rope access** describes techniques used to access structures or geologic features where ropes are the primary means of support, positioning, and fall protection. Generally, a two-rope system is used. Rope-access methods require

comprehensive training, specialized equipment, and perhaps most importantly, qualified supervision. Personnel must be individually assessed to specific performance standards, and comprehensive administrative procedures are necessary to assure that rope-access work is carried out safely.

### **Fall Protection**

The term *fall protection* is used generally to describe any system designed to prevent personnel from falling and sustaining an injury while working at height. Various methods of fall protection are employed for the different methods of access and support used by workers at height. These systems employ engineered controls, personal protective equipment (PPE), specialized access equipment, or a combination of all three. Generally, fall-protection systems will use PPE to catch, control, or restrain personnel while their weight is supported by other means, such as structures, walkways, or slopes.

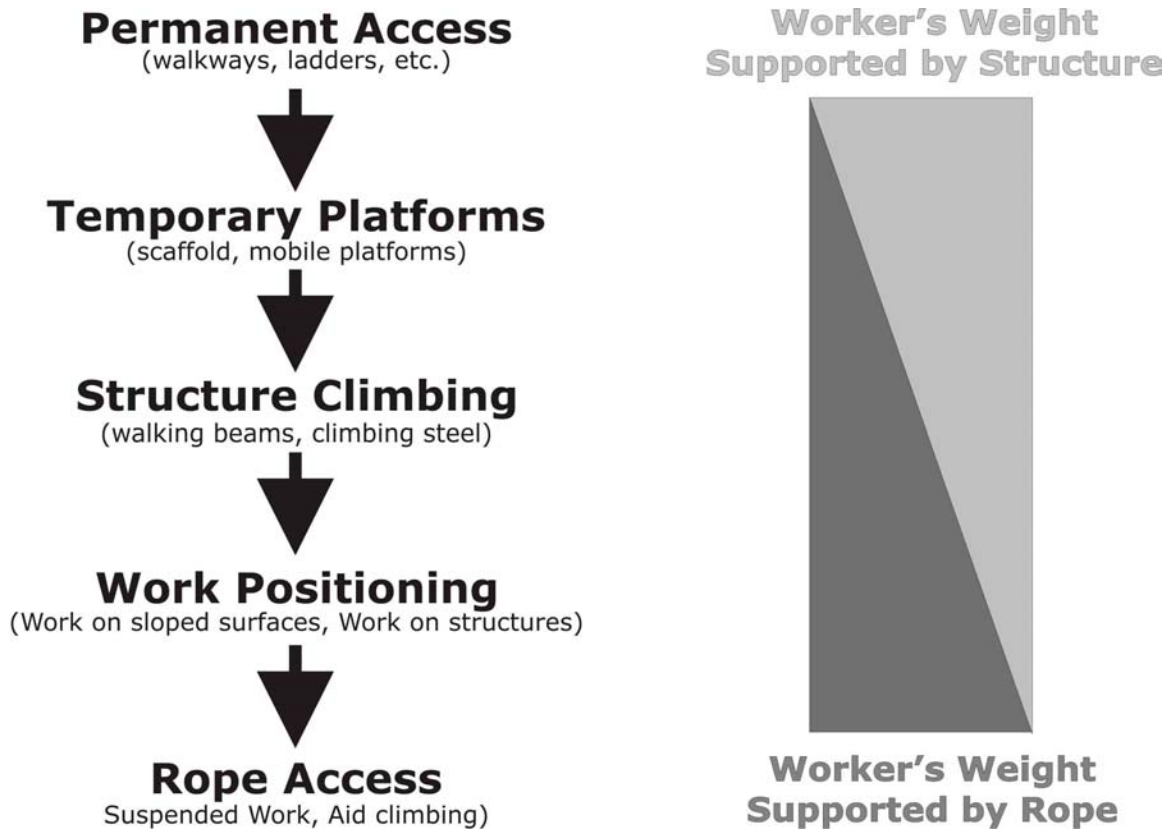
Fall-protection systems are required when an employee is within 6 feet (2m) of an edge where a fall of 6 feet (2 m) or more is possible. Fall protection is required on any slope where an uncontrolled fall or slide may occur especially on slopes greater than 1½:1 (horizontal: vertical). In practice, more moderate slopes require fall protection.

**Fall-restraint** systems (a.k.a. travel restraint) are designed to prevent falls by keeping employees from entering an area where the risk of falling exists. Restraint systems often employ the same basic equipment as fall-arrest systems and may be used on flat or sloping surfaces to keep a worker from reaching an exposed edge.

**Fall-arrest** systems are designed to safely arrest the fall of an employee. Arresting a fall once it occurs is less preferable than using an effective fall-







**Figure 1-4.** Access and Support Methods

restraint system, because injury can occur anytime a fall takes place.

**Applying Appropriate Fall Protection**

If the worker's weight is consistently supported by the structure or feature (e.g. moderate slope or climbing a ladder), then a single rope, or attachment point, can be used for fall protection. If however, the worker's weight is supported primarily by the rope or attachment point, a second line is required.

Many situations will require the worker to move in and out of work positioning, structure climbing, or rope-access situations. In these circumstances, the worker's back-up must remain attached to prevent a fall in the event of the failure of the primary system.

When climbing a structure, the worker's weight is supported by the structure, so a single rope may be used for fall protection.

In **work positioning** applications, the worker's primary means of support must still be the structure; the rope or lanyards are used to help prevent a fall. A second rope or attachment point may be required if a failure in the primary system may cause an uncontrolled fall.

Often working environments require multiple types of access be used concurrently; for example, a worker may use rope-access techniques to reach a platform, then use PPE (e.g. lanyards or



cow's tails) to secure themselves to the structure.

While a rope-access worker may use all of the various methods of access, support and fall protection, these guidelines focus on the application of rope-access equipment and techniques.

### **History of the Rope-Access Industry**

Modern rope access evolved from a synthesis of conventional fall protection and modern mountaineering techniques. These rope-access methods first proliferated on a commercial scale in Europe, where mountaineers and cavers began to adapt their equipment and techniques to the industrial environment.

The first known uses of modern recreational equipment for industrial applications occurred in the early 1960's<sup>1</sup>. In the late seventies to early eighties rope-access techniques were used in placing slope and rock stabilization in France. About the same time, inspectors used similar techniques in the United Kingdom (UK) for the examination of high-rise apartments with disintegrating concrete exteriors.

Rope access, as practiced today, started in the early to mid eighties using techniques based on methods developed by cavers that relied on the use of a single rope. To make the system appropriate for work at height, the original cavers' system was further developed during the eighties, employing a second backup, security rope to make the system more redundant and "bomb proof."

The application of rope-access techniques on buildings, bridges, and other structures

---

<sup>1</sup> "Rope access: from early beginnings to the future in the UK and beyond", Seddon, P., 2001, International Fall Protection Symposium, Orlando, FL, USA

such as radar dishes increased. The techniques transferred easily to offshore oil rigs in the North Sea, where difficult access problems were the norm. It is now a standard, worldwide procedure to use rope access for certain kinds of work such as inspection, cleaning, and painting on offshore rigs.

In 1987, six companies in the UK started the world's first rope-access trade organization – The Industrial Rope Access Trade Association (IRATA). The UK's government Health and Safety Executive was involved with IRATA from the outset and was a key participant, ensuring that rope access would be developed as a safe system.

In the beginning, rope-access workers were usually from a climbing or caving background, and later learned the work skills necessary for the industrial environment. This base, however, broadened to include many individuals who did not have such a background, starting instead as workers who had industrial skills, and then were trained to the new system. It is recognized that the safety record of rope access in the UK is now among the best in the construction industry, probably because most rope-access workers are trained to strict standards.

In the United States, the Society of Professional Rope Access Technicians (SPRAT) was founded in 1995 to provide national consensus standards for rope access. SPRAT differs from IRATA in that it is a member-based organization, representing both rope-access workers and rope-access companies. Reclamation is currently a sustaining member of SPRAT, and is participating in the development of national standards for the emerging industry. Both SPRAT and IRATA are also presently working to help set international standards for the rope-access industry.





**Figure 1-5.** High scaler on Hoover Dam

### **Reclamation and Rope Access**

Since its inception, the Bureau of Reclamation has used some form of rope access for working in vertical and steep environments, usually on the abutments of dams. Numerous dams in the American West required the use of ropes to allow workers to drill, scale, stabilize, and maintain the long, near vertical slopes associated with dams built in steep gorges. The most well known of these sites is Hoover Dam, where the high scalers became famous for their “daring” work on the cliffs high above the foundation in this steep, desert canyon. There is now a monument and café at the dam, immortalizing these early rope-access workers (Figure 1-5).

The system employed in Reclamation throughout these early days used manila rope with a wire core as the working line. The scalers used a modified boatswain’s

chair as the primary support, often equipped with a wooden seat for comfort. The chair was attached to the working line by two manila “pigtails” and a scaler’s hitch which allowed controlled slippage, thereby, limiting the descent rate of the operative. The use of these techniques by Reclamation continued almost unchanged into the 1990’s, despite the advent of high-strength synthetic ropes, better harnesses, and more adaptable equipment.

By the 1980s, various groups within the Bureau had begun using newer equipment, despite some reluctance of the Reclamation safety community to endorse such use. Workers in the Pacific Northwest Region began using nylon ropes designed for recreational climbers with the “traditional” boatswain’s chair harness. At that time, the nylon system was officially accepted only when the harness was also attached to a wire-core manila rope, instituting a two-rope system. The nylon rope was used with ascenders and descenders, but the operative remained attached to the manila lifeline at all times.

Various permutations of this method continued unofficially in different regions of the Bureau until the radial-gate failure at Folsom Dam in 1995. The gate was inspected using an ad-hoc team of people trained in various rope-access methods. Although the work was completed safely, it was apparent that Reclamation was in need of updated techniques and standards to address the developing rope-access field.

In 1996-1997, the first edition of the **Bureau of Reclamation Safety Guidelines for Rope-Supported Work** was developed. The revision of the Reclamation Safety and Health Standards, section **16.2 Rope Supported Safety Requirements** was subsequently adopted in 2002.



## **Philosophy**

Industrial rope-access techniques discussed in these guidelines require a different attitude than those prevalent in recreational climbing. In recreational climbing, climbing is the goal, and minimal equipment and the maximum use of personal skills are stressed. Many techniques, equipment, and safeguards that are considered adequate for sport climbing are either not applicable or potentially dangerous in an industrial setting. In industrial rope access, use of rope techniques is a job necessity, not a sport.

Rope access is never a means unto itself; it is merely a tool for completing a task. Rope-access techniques provide safe, efficient means for trained operatives to perform at a worksite that might be otherwise inaccessible. Rope-access techniques are now allowing inspection of Reclamation facilities, some of which have remained un-inspected since construction. As this field continues to mature, rope-access techniques are expected to become as widely used and accepted as scaffolding and swing stages.





## Chapter 2. Definitions

### General Definitions:

**Access Zone:** The area in which people are at risk of falling. (e.g. while on rope or close to a vertical drop of more than 6 feet).

**Aid Climbing:** A method of accessing a structure or site where the rope access operative moves by attaching directly to anchor points with special footloops and support devices. The method allows workers to climb horizontally underneath structures.

**Anchor:** A fixed attachment point, or series of points, on a structure which support the rope systems and other connections to personnel. A *critical anchor* is an anchor in which failure would result in serious consequences to the safety of the climber or integrity of the system.

**Belay:** A method or system used to manage the slack in the safety rope which provides fall protection to a rope access operative in the event of a fall or failure in the main support system.

**Attended Belay:** A belay system operated by a second person (other than the climber), that is applied to a moving safety rope.

**Self-belay:** The method used by a moving rope access operative to connect to a fixed safety rope (usually involving connecting a rope grab or clamp to the safety rope).

**Belayer:** A person, with appropriate training, that operates the *belay* system.

**Belay Rope:** see *safety rope*

**Certificate of Conformity:** Document provided by the manufacturer or a third-party testing lab (where required) showing conformity of equipment to a specific standard.

**Climber:** A term used generically (non-specifically) to refer to a rope-access operative that may be climbing, descending, or traversing a rope or structure. This term is used in the Reclamation Safety and Health Standards to designate a rope-access operative that has completed at least 32-hours of basic rope-access training.

**CSA:** Canadian Standards Association

**Emergency Medical System (EMS):** The local system of professional first aid, law enforcement, fire and rescue assistance.

**Fall Arrest:** A system designed to stop a fall and prevent injury resulting from a fall.

**Fall Protection:** A term used generally to describe any system designed to prevent personnel from falling or sustaining an injury resulting from a fall.

**Fall Restraint:** A system that prevents a person from entering an area where a risk of falling exists.

**Fall Factor:** A method of describing the proportional seriousness of a fall. The fall factor is defined as the maximum distance a worker can fall divided by the length of

rope (or connection) between the falling worker and the anchor. (See Chapter 8).

**Fall Line:** The straight path defined by an object when it is dropped and subjected to gravity.

**Fixed Rope:** A rope securely attached to an anchor point.

**Hazard Zone:** Any area where workers or public are at risk of injury from the actual work being performed (e.g. falling tools, etc.).

**Job Hazard Analysis:** A written evaluation produced by the Rope Access Technician of the hazards likely to be encountered while performing a work project, and how those hazards are best mitigated by planning, precautions, equipment use, and PPE. The document will describe how a particular job or series of jobs will be performed to minimize the risks to the safety of workers and public.

**Kernmantle Rope:** A synthetic rope with a load-bearing internal core (kern) and a protective outer sheath (mantle).

**Lead Climbing:** A method of protecting the first person who is climbing or traversing a structure, when a rope or safety system is not pre-installed. The safety rope is connected to anchor points at regular intervals as the climber progresses.

**OSHA:** Occupational Safety and Health Administration

**Peak Impact Force:** The maximum force experienced by the body during a fall.

**Personal Protective Equipment (PPE):** Equipment designed to protect worker from hazards in his work environment (e.g. helmet, gloves, safety glasses, etc.)

**Rescue:** The act of moving an injured or incapacitated worker(s) from the Access Zone to an area where more definitive medical care can be administered.

**Rope Access:** Techniques by which access is gained to structures (e.g. buildings, radial dam gates, bridges, penstocks) and geologic features (e.g. cliffs, steep slopes) where ropes are the primary means of support, positioning, or safety protection.

**Rope Access Permit (RAP):** See **JHA**

**“Shall” and “Should”:** The provisions are mandatory in nature where the word “shall” is used and advisory in nature where the word “should” is used.

**Safe Working Load (SWL):** The maximum load which an item of equipment may raise, lower or suspend under particular service conditions.

**Safety (Back-up) Rope:** Rope used to protect the worker in the event of a fall if the primary means of support (e.g. working line, ladder, anchor, etc.) fails.

**Safe Zone:** Any area outside the *Hazard Zone* or the *Access Zone*.

**Society of Professional Rope Access Technicians (SPRAT):** A non-profit organization that represents Rope Access professionals and develops industry standards for Rope Access Work in North America and abroad.

**Working Load Limit (WLL):** The maximum load (as determined by the manufacturer) that an item of equipment is designed to raise, lower or suspend.

**Working Rope:** The primary load-bearing rope used for descending, ascending, or positioning.

**Work Positioning:** Techniques for supporting a person while working by using specialized equipment in tension in such a way as to prevent a fall.

**Work Restraint:** See Fall Restraint.

**Personnel Definitions**



**Rope Access Supervisor:** An individual responsible for assessing the skills of climbers (Chapter 3). Qualifications and responsibilities are outlined in Chapter 3 (Designated as a team leader in the RSHS).

**Independent Certifier:** A person outside the Bureau of Reclamation certified or qualified by a nationally recognized organization who is authorized to evaluate rope-access candidates for certification.

**Rope-access Program Manager:** An individual suitably knowledgeable, experienced and qualified in rope access techniques, designated by the employer, to be the main contact point for matters relating to the safety, training, regulations, and additional responsibilities outlined in Chapter 3.

**Rope-access Safety Board:** A Reclamation-wide group of rope access personnel consisting primarily of regional representatives which oversee the training, qualification, certification, and safety review of all Reclamation rope access activities.

**Rope-access Technician:** A qualified operative, designated by the *RA Program Coordinator*, that has the skills and training of the *Rope Access Technician* and serves as a team leader with the additional responsibilities outlined in Chapter 3 (Designated as a climber or team leader in the RSHS).

**Rope-access Worker:** An individual capable and responsible for conducting rope access operations and other responsibilities outlined in Chapter 3 and has satisfactorily completed all minimum training requirements for rope access work (Designated as a climber in the RSHS)



## Equipment Terminology

**Ascender:** Device (usually used in pairs) that is designed to grip the rope for the purpose of ascending.

**Back-up Device:** A rope grab used by the worker to manage their own back-up safety system while working suspended on the main working rope.

**Belay Device:** A friction device used to manage the slack in the safety rope.

**Carabiner:** A connector made of steel or aluminum with a self-closing, spring-loaded gate opening. Locking carabiners are equipped with a positive locking mechanism provided by various mechanisms (see chapter 5).

**Connector:** Device made out of metal (steel or aluminum) used to connect elements of the rope-access or fall-protection system together.

**Cow's Tail:** Slang for dynamic rope lanyards with sewn, swaged, or knotted terminations.

**Descender (Descent Control Device):** A device that applies friction to a rope for the purpose of helping the operator control his/her rate of descent. Most descenders can be connected to a fixed anchor to lower an employee.

**Energy Absorbers:** Components within a life-safety system that dissipate the forces generated in a fall.

**Helmets:** Head protection designed to meet general industry standards as well as special requirements for working at height, such as chin-straps.

**Kernmantle Rope** (Dynamic; Low-stretch): Synthetic (usually nylon or polyester) rope with a load-bearing core (kern) and protective woven sheath (mantle).

**Lanyards:** Webbing or rope connections used between the harness and other items of equipment or the structure.

**Multi-purpose Harness:** A full-body harness designed to be comfortable while working suspended; used for fall-restraint, work-positioning, rope-access, and fall-arrest applications.

**Pulleys:** Friction-reducing wheeled devices used to change the direction of a rope or create mechanical advantage through proper rigging.

**Quick-links:** Connectors with a barrel which screws into the locked position, especially suited for multi-directional loading.

**Rope Protectors:** Various devices, made from canvas, plastic, or metal that are used to protect the rope from damage from sharp or abrasive edges.

**Webbing Slings:** Multi-purpose sewn synthetic slings commonly used for rigging in anchors.

**Wire rope Slings:** Durable slings made out of wire rope (minimum 7 mm diameter) that are often used for anchors, especially suited for use on steel structures.

**Work Seat:** A seat board that can be added to a work-positioning or rope-access system to make suspension while working more comfortable.







## Chapter 3. The Rope-Access Team

This chapter outlines qualifications, training requirements, responsibilities, and the certification of rope-access personnel.

### Team Size

A Reclamation team must have a minimum of three certified rope-access operatives on all rope-access work sites, one of which must be a rope-access Technician as listed in Table 3-2. This minimum is designed to assure that trained personnel are available on site in the event of an emergency. The team shall be larger for more complex operations where one standby individual cannot provide adequate emergency response. Team size shall be considered in preparation of the Job Hazard Analysis, and the team size based on the work complexity and potential rescue requirements.

Other untrained personnel can assist in non-technical work, but may not substitute for any of the three trained rope-access individuals. Rope-access personnel must assure that non-trained personnel are fully briefed on the unique safety requirements of rope-access work.

### Selection of Rope-Access Personnel

Selection of candidates for rope access must be done carefully, with consideration given to each person's aptitude, rope-access experience, professional background, and his or her willingness to function as a member of a team. Where a team lacks specific experience for a particular task, personnel from outside the team can be brought in to supplement the skills of the core group. Selection criteria for rope-access personnel is summarized in Table 3-1.

### Physical Requirements

All rope-access personnel must be in good physical health. Prior to initial training, a physical examination is required to confirm that the individual is able to undertake the strenuous activity demanded by the work. Candidates must be sufficiently physically fit and free from any disability which may prevent them from working safely. It is the employee's responsibility to notify supervisors and team leaders of any medical condition that may affect his/her ability to perform necessary duties, or pose a risk to their own safety or that of their partners. Rope-access personnel must have an annual physical examination (per RSHS 16.2.11), and be cleared to continue rope-access work.



**GET FIRST AID TRAINED.**  
*It may make the difference  
between a life-threatening situation  
and a minor incident.*

### Aptitude

Rope access can be a demanding activity, both physically and mentally. Rope-access personnel are often required to perform difficult physical tasks under arduous climatic and environmental conditions. The successful rope-access employee must be team oriented, inherently safety conscious, possess a calm disposition even in severe circumstances, and must not be susceptible to an unreasonable fear of heights. Even the most experienced team member must maintain a willingness to learn new skills or techniques. A successful rope-access team requires the thoughtful input of all members, not just those charged with supervising the job.

**Table 3-1: Recommended Employee Criteria for Rope Access Work**

**Mental Aptitude**

- Ability to work in a harness and at height
- Healthy respect for heights
- Consistent safety attitude
- Willingness to learn and improve
- Team orientation
- Ability to perform physically and mentally demanding work under adverse conditions
- Willingness to analyze and solve unforeseen changes in rope work plans

**Physical Attributes**

- Capable of working in climatic extremes
- Ability to work while suspended in harness for extended periods of time
- Good strength-to-weight ratio
  - Body weight of 220 lbs recommended maximum for people up to 6 ft tall
  - Ability to climb, lift, and hold body weight
- Ability to lift and carry heavy objects
  - 55 lbs for 165 ft (25 kg for 50 meters)

- Average to good cardio fitness
- climb 50 stairs without physical distress or prolonged elevated heart rate (Reference: Harvard Step Test)

- Healthy joints and full-function of extremities (especially hands)

**Possible Limitations/Concerns**

- Heart disease or hypertension
- Epilepsy, seizures, or blackouts
- Dizziness or impaired balance
- Severe allergic reaction to insect bites (anaphylactic shock)
- Brittle or uncontrolled diabetes
- Peripheral Vascular Disease (poor blood circulation to extremities)
- Bleeding Disorders
- Medication that affects alertness, balance, judgment, or vision
- Psychiatric Illness
- Extreme Sunlight Sensitivity
- Severe tendonitis or arthritis
- Severe back, neck, or shoulder problems
- Severe hearing loss
- Obesity

**Personal Responsibility**

Each employee must take responsibility for their own safety as well as that of their teammates. Each team member must be present at, and fully participate in, pre- and post-project safety discussions.

Where team members are not present for pre-project safety meetings (such as when members arrive the day after work begins), they shall be informed in detail by the technician or supervisor of the job hazards, special safety procedures, and details of the work before participating in rope-access work. It is incumbent upon

each team member to personally assess the dangers involved with any action considered by the team, and to avoid any action that exceeds his/her comfort level or skill.



**Each person has the right and the responsibility to refuse to participate in work which he/she deems unsafe.**



### **Gear Requirements**

Each team must be equipped with an adequate supply of suitable gear for the tasks at hand. The rope-access technician must know how the entire system functions under various conditions, and use such equipment appropriate for that situation. Each team must procure and maintain gear. Certain gear such as helmets, harnesses, safety glasses, and gloves are generally issued to the individual, while ropes, pulleys, and anchor straps, are generally treated as team gear. Gear must comply with Reclamation requirements in sections 16.2.2, 16.2.4, 16.2.5, and 16.2.6 of the Safety and Health Standards.

Modifications to gear, or the introduction of homemade equipment, are not permitted unless reviewed and specifically approved by the Rope Access Safety Board. Chapter 5 of these guidelines will address the selection and proper use of equipment.

### **Roles, Responsibilities, Training and Qualification of Personnel**

One of the cornerstones of safe rope-access work is the training each individual receives. Each person must undergo 32 hours of Reclamation-approved, introductory rope-access training to be allowed to participate on a rope-access team. The training must include the following (see Appendix 1 for training curriculums):

- ❖ Rope-access safety and fall hazards
- ❖ Applications of equipment
- ❖ Estimating fall factors and distances
- ❖ Basic Rescue
- ❖ Compliance with the requirements in the Reclamation Safety and Health Standards

These guidelines designate three skill levels of rope-access operatives: worker, technician, and supervisor. Please note that these levels have been designated to

conform as nearly as possible to both RSHS and skill certifications offered by SPRAT and IRATA. As SPRAT is the recognized North American standard, these guidelines have adapted the SPRAT terminology.

**Worker** - A BOR rope-access Worker (referred to as a *climber* in the RSHS) must complete the initial 32-hour training, and be qualified by a Rope-Access Supervisor. The Worker is responsible for knowledge of and compliance with all provisions in RSHS section 16.2. and shall be able to:

- inspect his/her own personal rope access equipment and safety system
- perform a variety of maneuvers on rope comfortably
- assist in rigging and non-standard operations, under the guidance of a more experienced and trained worker
- complete a rescue involving descent or lowering and have a basic understanding of hauling systems.

After basic training is completed, rope-access Workers will continue training on the job under a rope-access technician's direction.

The Worker must complete 32 hours of developmental training *annually* to maintain his or her standing with Reclamation. The annual training must include written documentation of a skills evaluation. This annual requirement can be reduced to 16 hours of training if the Worker has logged at least 40 hours of on-rope experience in the preceding 12 months. The BOR qualification will be valid for 1 year.

As directed by the RSHS, every three years, the Technician and a rope-access Supervisor will re-evaluate the experience and overall skill of each qualified Worker. To maintain credibility and objectivity, the Supervisor must not have worked any rope-access projects with either the Worker candidate or the Technician in the



preceding year. If the Worker's skill is found to be inadequate, the Worker must retake the basic qualification course or complete a focused training course designated by the Technician, or at the discretion of the Technician, not be re-qualified.

**Technician:** The rope-access Technician is responsible for, and will directly oversee, all rope-access operations conducted by his/her team (referred to as team leader in the RSHS). The technician shall be present on-site during all rope-access operations. The technician serves as the communication hub between management, rope-access personnel, safety officials, and local emergency personnel during all aspects of the job. The Technician verifies the experience and physical qualifications of the members of the rope-access team.

The Technician must hold a journeyman-level, rope-access certification by an independent outside organization approved by the BOR Rope-Access Safety Board (such as SPRAT Rope-Access Technician or IRATA Level II technician) and be a qualified rope-access Technician by the BOR. For BOR qualification, a rope-access Technician must also complete 32 hours of developmental training each year. This requirement can be reduced to 16 hours annually if the technician has at least 40 hours of on-rope experience in the preceding 12 months. Designation as a Technician will be through completion of an advanced written test, and a demonstration of advanced rope-access skills administered by a rope-access Supervisor. The designation as Technician may be done at the Reclamation regional level by personnel familiar with rope-access standards and guidelines.

The Technician must have experience in the type of work to be performed, be able to write the job-hazard analysis, and have

an excellent understanding of rope-access systems.

**Rope-Access Supervisor:** The Rope-Access Supervisor (referred to as Climbing Certifier in the RSHS) can function both as a trainer and evaluator for Reclamation rope-access personnel. The Supervisor is responsible for administering the BOR qualification for candidates for rope-access Worker and Technician.

Supervisors must be familiar with the pertinent skills in the rope-access field as it applies to BOR work. Supervisors must maintain qualification and certification requirements for Reclamation's Technician, complete the annual training required for a rope-access Technician, plus 16 hours of advanced developmental training, and maintain an appropriate independent certification for rope-access expertise (e.g. SPRAT's rope-access Supervisor).

Qualification of the individual as a BOR rope-access Supervisor will be done solely by the BOR Rope-Access Safety Board. The Board will consider the candidate's work experience, knowledge and proficiency in the rope-access field, ability to teach and evaluate students, and other factors as the Board deems relevant.

### **Medical Training**

Rope-access personnel must be currently certified in Red Cross-approved First Aid and Cardiopulmonary Resuscitation (CPR). Training in advanced first aid is also desirable. Rope-access supervisors must complete an advanced first aid or equivalent medical training to assure correct response during training or certification sessions.

### **Documentation of Hours**

All BOR rope-access personnel must maintain a personal log of rope-access experience and training activities to aid in



re-certification. This information shall include the dates of training with the BOR supervisor's or independent certifier's signature and medical information relevant to rope-access work. Rope-access tasks shall be logged with the following information: dates and hours of

work, details of work tasks, location, and the rope-access technician's initials for each rope-access job. (Log books such as those published by SPRAT can be used for each rope-access operatives personal information).

**Table 3-2.** Training and Certification Requirements

Level	Initial Training	Annual Training	Certification / Qualification Required	Who Does Certification/ Qualification?	Review Length
<b>Worker</b>	32 hours + exam	16-32 Hours (depending on experience)	BOR qualification	BOR (independent certification optional)	1 year
<b>Technician</b>		16-32 Hours (depending on experience)	Outside certification for RA Technician + BOR qualification	Independent and BOR for Technician	1 year
<b>Supervisor</b>		16-32 Hours (depending on experience) + 16 Hours Advanced	Outside certification for RA Supervisor + BOR qualification	Independent and Safety Board for Supervisor	1 year

**Additional Team Responsibilities**

In addition to these skill level designations, it is recommended that each team designate additional responsibilities to at least two of the working members:

**Equipment Manager** – Each team should designate one of its team members to act as the equipment manager for the group equipment. The manager shall be responsible for maintaining a systematic and complete record of all equipment used by the team as outlined in Chapter 5 – **Equipment**. The manager shall inspect the equipment after each use, and retire and replace equipment that is obsolete, damaged, or exceeds the manufacturer's recommended working life.

**Rope-access Program Coordinator** –

Each team should also designate a person suitably knowledgeable, experienced and qualified in rope-access techniques, designated by the Region, who will serve as the main contact point for matters relating to the safety, training, regulations, and additional regional or area team responsibilities as outlined in Chapter 4.

**Rope-Access Safety Board**

The Rope-Access Safety Board will oversee the training, qualification, certification, guidelines and standards for Bureau rope-access activities. The Board will consist of rope-access representatives from each region, and as many other members-at-large, such as Reclamation



safety staff, rope-access instructors, or outside supervisors as the regional representatives deem necessary.

The Reclamation Safety Manager holds the responsibility and authority to conduct investigations of serious accidents. The Rope Access Safety Board holds the rope-access expertise and shall provide representatives to participate on serious accident investigations of rope access accidents. The representatives shall be selected by the Rope Access Safety Board from a rope access team and office that are not involved in the accident.





## Chapter 4. Standard Procedures

Every job involves unique challenges and hazards. This chapter addresses standard procedures rope-access personnel must follow to mitigate these hazards and assure that the work progresses in a safe and efficient manner. Developing a work routine and using checklists can help assure all foreseeable hazards have been considered.

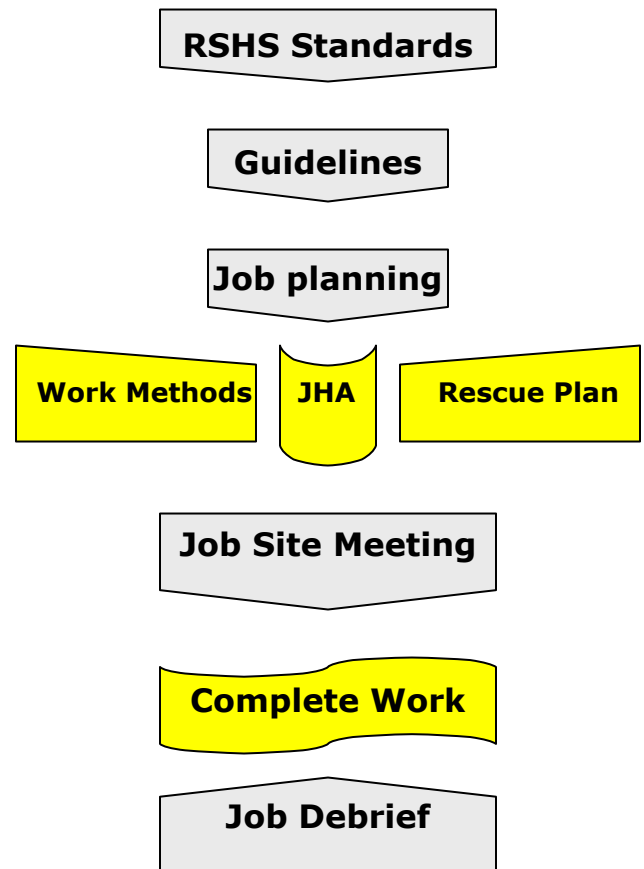
### Reclamation Safety and Health Standards (RSHS)

The Bureau of Reclamation has established extensive safety and health standards covering a broad range of activities. In the latest revision (2001), the **Reclamation Safety and Health Standards (RSHS)** address fall-protection and rope-supported work in Section 16. Specifically section 16.2 is devoted entirely to rope-supported work. Entitled "Rope Supported Safety Requirements," the section covers a variety of topics from equipment to personnel training, and serves as the foundation for these Guidelines.

Several risk management and planning levels must be considered prior to commencing rope-access work as shown in Figure 4-1.

- The RSHS establishes BOR requirements for rope-access work;
- These *Guidelines* outline standard procedures and recommendations for how generally rope-access work *shall* be carried out;
- The Job Planning stage must involve identifying work methods, completing a job hazard analysis, and detailing a rescue plan;
- The work methods, JHA, and Rescue Plan must be discussed with all of the personnel at the jobsite meeting.
- After completing, the work a job debrief meeting and/or report

should be filed identifying any near misses, safety issues, and technique improvements.



**Figure 4-1.** Relationship between Standards, Guidelines, and Job Planning in order to manage risk in rope-access work.

**Job Planning**

The Job Planning stage requires identifying the hazards, determining work methods that will mitigate these hazards, and outlining a rescue plan in the event of an emergency.

Knowledge of the worksite, awareness of the hazards involved, familiarity with local personnel and emergency services are all crucial to planning a safe rope-access job. At a new or unfamiliar site, a preliminary site visit by the rope-access technician or even the whole team may be necessary to assure the work is completed in a safe and expedient manner.

The rope-access Technician/Team Leader is responsible for completing the work plan and job hazard analysis (JHA) prior to the commencement of any rope-access work. All team members **must** review, comment, and sign the JHA prior to commencing the job.

An example of a JHA is included in the appendix. Additional information about writing JHA's can be found in Reclamation Safety and Health Standards under Section 4 – Work Planning.

A table of common hazards and their implication for rope-access work is shown in Table 4-1.

**JHA's Shall include:**

- ❑ Site of rope-access work
- ❑ Dates of planned work
- ❑ Purpose of the work
- ❑ Rope-access personnel
  - Titles
  - Rope-access experience and certifications
  - Mailing Addresses and mail stops
  - Emergency contact numbers
  - Team Leader designation
- ❑ Additional personnel
  - Project or site representatives
  - Safety Officers or S&H Professional
- ❑ Emergency phone numbers
  - Project contacts
  - Local emergency response contacts
- ❑ Communications during the work
- ❑ Structure and equipment status
- ❑ Lock out/ tag out procedures
  - Facility or site contact name and number
  - Special site or program requirements
  - Equipment necessary
- ❑ Expected conditions during the work
- ❑ Hazards that may be encountered during the work
  - Weather
  - Biological (critters, insects, etc.)
  - Rock fall
  - Wet conditions
  - Toxic/Low oxygen environments
  - Height exposure
  - Low-light conditions
  - Dropped equipment
  - Confined space entry plan
  - Confined space air monitoring plan
- ❑ Work Methods
- ❑ Rescue plan, equipment and personnel





**Table 4-1. Job Hazards**

	<b>Condition</b>	<b>Description of Hazards</b>		<b>Control Measures</b>
<input type="checkbox"/>	<b>Falling</b>	<ul style="list-style-type: none"> <li>Gravity-induced injury or death</li> </ul>	<input type="checkbox"/>	Always use appropriate fall-protection or rope-access equipment when 6 feet from unprotected edge with a fall potential of 6 feet or more All personnel must be properly trained
<input type="checkbox"/>	<b>Human Error</b>	<ul style="list-style-type: none"> <li>Rigging Errors</li> </ul>	<input type="checkbox"/>	Use 2-rope system when working line is primary means of support Use independent anchorages Always do 4-point check: Ropes (including anchors), Hardware, Harness, Helmet
<input type="checkbox"/>	<b>Communication Difficulty</b>	<ul style="list-style-type: none"> <li>Loud ambient noise (traffic, machinery, running water, wind, etc.)</li> <li>Malfunctioning or dropped radios</li> <li>Conditions change</li> </ul>	<input type="checkbox"/>	Agree upon and use standardized communication signals Check communication system Designate alternate communication system in case conditions change or technical difficulties arise Review hand signals (as appropriate)
<input type="checkbox"/>	<b>Sharp/abrasive surfaces</b>	<ul style="list-style-type: none"> <li>Rope or anchor damage and/or failure</li> <li>Abrasions or cuts to hands</li> </ul>	<input type="checkbox"/>	Use proper edge protection and padding Use re-direct or intermediate anchors as needed Wear gloves and proper clothing
<input type="checkbox"/>	<b>Electrical Lines</b>	<ul style="list-style-type: none"> <li>Inadvertent contact with energized lines</li> <li>Burns or electrocution from contact</li> </ul>	<input type="checkbox"/>	Examine lines that might be contacted by wind-blown ropes Get appropriate clearances Follow lock-out/tag-out procedure
<input type="checkbox"/>	<b>Machinery</b>	<ul style="list-style-type: none"> <li>Inadvertent operation of machinery</li> <li>Injury sustained from machinery</li> <li>Hazardous condition created (e.g. release of water)</li> </ul>	<input type="checkbox"/>	Get appropriate clearances Follow lock-out/tag-out procedure Confirm lock-out/tag-out
<input type="checkbox"/>	<b>Injury from Tools</b>	<ul style="list-style-type: none"> <li>Hazards depend on tools used</li> <li>Damage to rope-access or fall-protection system</li> </ul>	<input type="checkbox"/>	Follow all manufacturers instructions and keep all protective guards in place Separate suspension rope may be required for tools greater than 10 kg
<input type="checkbox"/>	<b>Dropped Tools or Materials</b>	<ul style="list-style-type: none"> <li>Possible injury to personnel and public</li> <li>Loss of important tools for work or egress</li> <li>Damage to structures or equipment</li> </ul>	<input type="checkbox"/>	Clearly mark and barricade Hazard Zone Helmets or hard hats must be worn in Hazard Zone Keep a clean and orderly worksite All tools and devices must be tethered or secured Avoid working or standing below other workers
<input type="checkbox"/>	<b>Rock fall or loose detritus</b>	<ul style="list-style-type: none"> <li>Possible injury to personnel and public</li> <li>Damage to structures or equipment</li> <li>Severed ropes</li> </ul>	<input type="checkbox"/>	Careful scaling or clearing of slope prior to work Loose materials or rock may need to be secured (either temporarily or permanently) Manage ropes carefully to avoid dislodging loose materials
<input type="checkbox"/>	<b>Rain/Wet Conditions</b>	<ul style="list-style-type: none"> <li>Insulating qualities of wet clothing decreases</li> <li>Possible hypothermia (dangerously low body temperature)</li> <li>Wet surfaces can be slippery</li> <li>Decreased friction on descent and rope-grab devices</li> <li>Danger of stray current near improperly insulated and grounded equipment</li> <li>Decreased visibility</li> </ul>	<input type="checkbox"/>	Stop work if conditions become dangerous Wear proper footwear and clothing Waterproof rain gear should be available Be aware of slippery conditions Electrical equipment must be adequately grounded and equipped with GFCI's.
<input type="checkbox"/>	<b>Snow/Ice</b>	<ul style="list-style-type: none"> <li>Insulating qualities of wet clothing decreases</li> <li>Possible hypothermia (dangerously low body temperature) and frostbite</li> <li>Loss of dexterity in extremities</li> <li>Wet and icy surfaces are slippery</li> <li>Decreased friction on descent and rope-grab devices</li> <li>Danger of stray current around improperly insulated and grounded electrical equipment</li> <li>Decreased visibility</li> </ul>	<input type="checkbox"/>	Stop work if conditions become dangerous Wear proper footwear and clothing, including gloves and hat Waterproof rain gear should be available Be aware of slippery conditions Use appropriate rope access equipment for conditions Electrical equipment must be adequately grounded and equipped with GFCI's. Hand warmers should be available in case of emergency



	<b>Condition</b>	<b>Description of Hazards</b>		<b>Control Measures</b>
<input type="checkbox"/>	<b>Water</b> (working around/over moving/standing water)	<ul style="list-style-type: none"> <li>Wet surfaces can be slippery</li> <li>Potential for Drowning</li> <li>Trapped in current while tied off (drowning hazard)</li> </ul>	<input type="checkbox"/> <input type="checkbox"/> <input type="checkbox"/> <input type="checkbox"/>	<input type="checkbox"/> Stop work if conditions become dangerous <input type="checkbox"/> Rescue boat shall be readily available if working directly over water, especially if descent is a viable method of egress. <input type="checkbox"/> Fall protection or rope access equipment must not allow worker to fall into water (especially moving water) <input type="checkbox"/> Personal flotation devices not required if proper fall protection in place
<input type="checkbox"/>	<b>Sun/Heat</b>	<ul style="list-style-type: none"> <li>Possible dehydration, heat exhaustion or heat stroke</li> <li>Burns from tools, equipment, and structural steel</li> <li>Adhesives and first-aid supplies may be degraded by heat</li> </ul>	<input type="checkbox"/> <input type="checkbox"/> <input type="checkbox"/> <input type="checkbox"/> <input type="checkbox"/>	<input type="checkbox"/> Stop work if conditions become dangerous <input type="checkbox"/> Ample water and/or electrolytes must be on hand for workers <input type="checkbox"/> Schedule proper breaks and work in morning or evening to avoid peak temperatures <input type="checkbox"/> Wear gloves and proper clothing to protect hands from hot surfaces <input type="checkbox"/> Use and frequently re-apply adequate sunscreen
<input type="checkbox"/>	<b>Cold/Freezing Temperatures</b>	<ul style="list-style-type: none"> <li>Possible hypothermia, frostbite, loss of dexterity in extremities</li> <li>Decrease in efficiency, adhesives and first-aid supplies may not function properly due to cold, water for drinking and work may be frozen; slippery surfaces</li> </ul>	<input type="checkbox"/> <input type="checkbox"/> <input type="checkbox"/>	<input type="checkbox"/> Stop work if conditions become dangerous <input type="checkbox"/> Wear proper footwear and clothing, including gloves and hat <input type="checkbox"/> Warm liquids should be available to workers
<input type="checkbox"/>	<b>Wind</b>	<ul style="list-style-type: none"> <li>Possible increased cooling or hypothermia risk, increased dehydration risk in dry humidity</li> <li>Decrease in efficiency, hindrance to communications between team members</li> <li>Danger of unsecured equipment or material being blown into the access zone</li> <li>Difficulty communicating</li> </ul>	<input type="checkbox"/> <input type="checkbox"/> <input type="checkbox"/> <input type="checkbox"/>	<input type="checkbox"/> Stop work if conditions become dangerous <input type="checkbox"/> Wear proper footwear and clothing, including gloves and hat <input type="checkbox"/> Secure loose materials at work site <input type="checkbox"/> Be wary of wind developing slack in ropes where they may be blown in to areas making retrieval difficult
<input type="checkbox"/>	<b>Lightning</b>	<ul style="list-style-type: none"> <li>Possible electrocution due to lightning strike, loss of consciousness or life</li> <li>Rope-access equipment may provide a pathway to the operative for electrical strikes</li> </ul>	<input type="checkbox"/>	<input type="checkbox"/> Stop work when lightning threatens
<input type="checkbox"/>	<b>Dimly lit or night work</b>	<ul style="list-style-type: none"> <li>Sharp or protruding objects (metal, nails, bolts, etc.) may not be visible to moving operatives, drowsiness of employees</li> </ul>	<input type="checkbox"/> <input type="checkbox"/>	<input type="checkbox"/> Provide adequate lighting: area lighting and/or head-and hand-lamps <input type="checkbox"/> Provide spare batteries, light sources, and bulbs
<input type="checkbox"/>	<b>Dust</b>	<ul style="list-style-type: none"> <li>Difficulty in breathing, possible allergic reaction</li> <li>Possible long-term exposure hazard</li> </ul>	<input type="checkbox"/> <input type="checkbox"/>	<input type="checkbox"/> Provide adequate engineering controls <input type="checkbox"/> Provide PPE where engineering controls not possible or impractical
<input type="checkbox"/>	<b>Chemical exposure</b>	<ul style="list-style-type: none"> <li>Difficulty in breathing, dizziness, unconsciousness</li> <li>Chemical burns to skin, eyes, internal organs</li> </ul>	<input type="checkbox"/> <input type="checkbox"/> <input type="checkbox"/>	<input type="checkbox"/> Workers must have MSDS on site for all chemicals used in work <input type="checkbox"/> Proper PPE and engineering controls must be in place <input type="checkbox"/> Respirators must be the correct type for the exposure
<input type="checkbox"/>	<b>Confined space entry</b>	<ul style="list-style-type: none"> <li>Work areas may contain toxic gases or insufficient oxygen levels for work.</li> <li>Space may have restricted entry/exit making access difficult,</li> </ul>	<input type="checkbox"/> <input type="checkbox"/>	<input type="checkbox"/> Follow confined space procedures <input type="checkbox"/> Toxic rescue plan required and in force prior to entry
<input type="checkbox"/>	<b>High-noise area</b>	<ul style="list-style-type: none"> <li>Permanent or temporary damage to hearing</li> <li>Difficult Communications</li> <li>High-noise levels may mask warning buzzers or other alert sounds</li> </ul>	<input type="checkbox"/> <input type="checkbox"/> <input type="checkbox"/>	<input type="checkbox"/> Hearing protection required, in extremely loud environments (+120 dBA), multiple types of protection may be necessary. <input type="checkbox"/> Agree on hand signals before work starts <input type="checkbox"/> Workers may be equipped with sound-isolating hearing protection for radios.
<input type="checkbox"/>	<b>Insect or animal bites or stings</b>	<ul style="list-style-type: none"> <li>Possible injury or incapacitation of personnel depending on severity of bite or venom</li> </ul>	<input type="checkbox"/> <input type="checkbox"/>	<input type="checkbox"/> Careful access into areas where spiders, snakes, scorpions, or other creatures may reside. <input type="checkbox"/> Use of gloves at all times, equip first aid kit with medical supplies appropriate for bites and stings.



	Condition	Description of Hazards		Control Measures
<input type="checkbox"/>	<b>Vehicular Traffic</b>	<ul style="list-style-type: none"> <li>Possible impact or crushing injury</li> </ul>	<input type="checkbox"/> <input type="checkbox"/> <input type="checkbox"/>	Careful demarcation of access and hazard zones, Use flags, signs, flag persons, lighting as needed Provide high-visibility clothing for personnel
<input type="checkbox"/>	<b>Animal Feces</b>	<ul style="list-style-type: none"> <li>Possible inhalation of disease carried by feces</li> </ul>	<input type="checkbox"/>	Workers may need to wear protective gloves or respirators.

**Onsite Clearances**

All relevant facility clearance must be obtained prior to beginning work. Notification of on-site personnel must include permission to access the facility, access to locked or otherwise restricted locations or structures, notification of security personnel, notification of other on-site workers or contractors, and possibly notification of law-enforcement personnel.

Permission should be obtained in writing, if possible. Where access involves work on structures or systems that can be energized (such as spillway gates, power lines, valves, or any type of moving system that might endanger the working personnel), written clearances must be obtained, and BOR and local procedures followed (See **Lock-out/Tag-out** below). Copies of the site clearances must be kept and maintained by the team leader.

If an energy isolating device is capable of being locked out, lockout procedures must be followed unless the site supervisor can justify an operational need to use a tag-out system instead.

Where differing standards and guidelines are encountered locally, the team shall implement the most stringent governing procedures. Rope-access teams should maintain a kit of tag-out equipment including personalized tag-out locks, multiple lock hasps, and any special lockout devices (e.g. valve isolators). Each lock must be marked with the owner’s name and contact information.

Additional information about Lockout/Tag-out procedures can be found in considerable detail in **Reclamation Safety and Health Standards** under Section 15 – Control of Hazardous Energy

**Communication**

Radios, or other communication equipment, must be available between each individual in the work crew if distance or distracting noise interferes with normal verbal or visual communication. The team may agree upon emergency hand and/or whistle signals, however maintaining consistent verbal communication is of primary importance.



Tip: Don’t forget to charge the radio batteries!

Communication with other relevant personnel, especially facility operators, must be considered.



**Lock-out /Tag-out**

If machinery or systems in the vicinity of rope-access work can be moved, energized, opened or operated strict lock-out/tag-out procedures must be followed. Reclamation has clear requirements for such operations in the **Safety and Health Standards** under Section 15 – Control of Hazardous Energy.



Standard commands must be agreed upon whenever working on rope. Each command must not be easily confused with other commands. Some standard commands are suggested in Table 4-2. It is not necessary to use these exact commands as long as the whole team agrees upon the same commands.

**Table 4-2: Common Commands**

Climber: On Belay?  
 Belayer: Belay On!

Climber: Climbing?  
 Belayer: Climb On!

Climber: Slack!  
 Belayer: Feeds out rope

Climber: Up Rope!  
 Belayer: Takes in rope

Climber: Tension!  
 Belayer: Takes in rope tight and holds

Climber: Falling!  
 Belayer: Prepares to catch a fall

Climber: Off Belay!  
 Belayer: Belay Off! (after disconnected)

**Emergency Communication**

Arrangements for notification of emergency-response personnel must be arranged prior to beginning work. It is recommended that local police, fire departments, or emergency-medical personnel need to be notified prior to the work, and the emergency-notification system checked. Standard telephone lines, cellular telephones, satellite phones, or two-way radios may all be communication options depending on remoteness of the site. Emergency-response personnel must know exactly where the work is being

conducted prior to any work beginning, and how to reach the site.

For a more thorough discussion of Emergency Procedures see **Chapter 11** of these guidelines.

**Work Zones**

The work site for rope access can usually be divided into three areas: the Access Zone; the Hazard Zone; and the Safety Zone (Figure 4-3, 4-4). The Access Zone is defined as the area in which people are at risk from falling such as on-line or near a working edge. The Hazard Zone is any area where a person may be at risk as a result of the work being performed. The Safe zone is any area outside the Hazard Zone or the Access Zone.

The Access Zone is the area where fall protection, fall-restraint, or rope-access techniques are required for safe work. Anchor points should be placed outside the Access Zone so that the worker can connect to the safety system before entering. Where the Access Zone is accessible to individuals other than the rope access



**Figure 4-2: Hazard Zone**

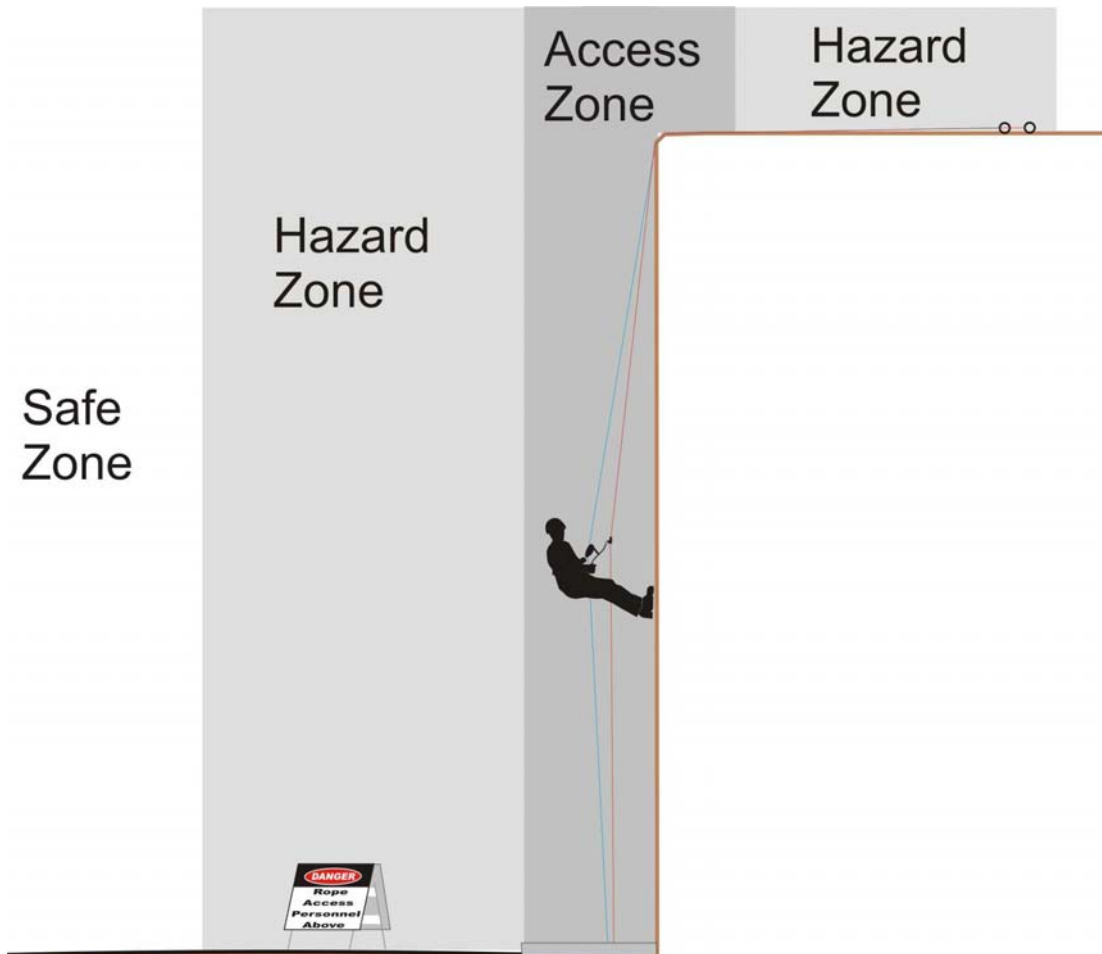


personnel, the area shall be appropriately marked with signs or warning tape. This procedure may also serve to protect the rope-access workers below from outsiders tampering with anchors, knots, and rigging.

Frequently the Hazard Zone (Figure 4-2) is below working rope-access personnel where any dropped or dislodged item might cause injury to workers or the public. Signs or warning tape can be used to prevent people from entering the Hazard Zone. Additional personnel may also be necessary to act as attendants both above and below the work area to make sure outsiders are not injured by straying into the Access or Hazard Zones.

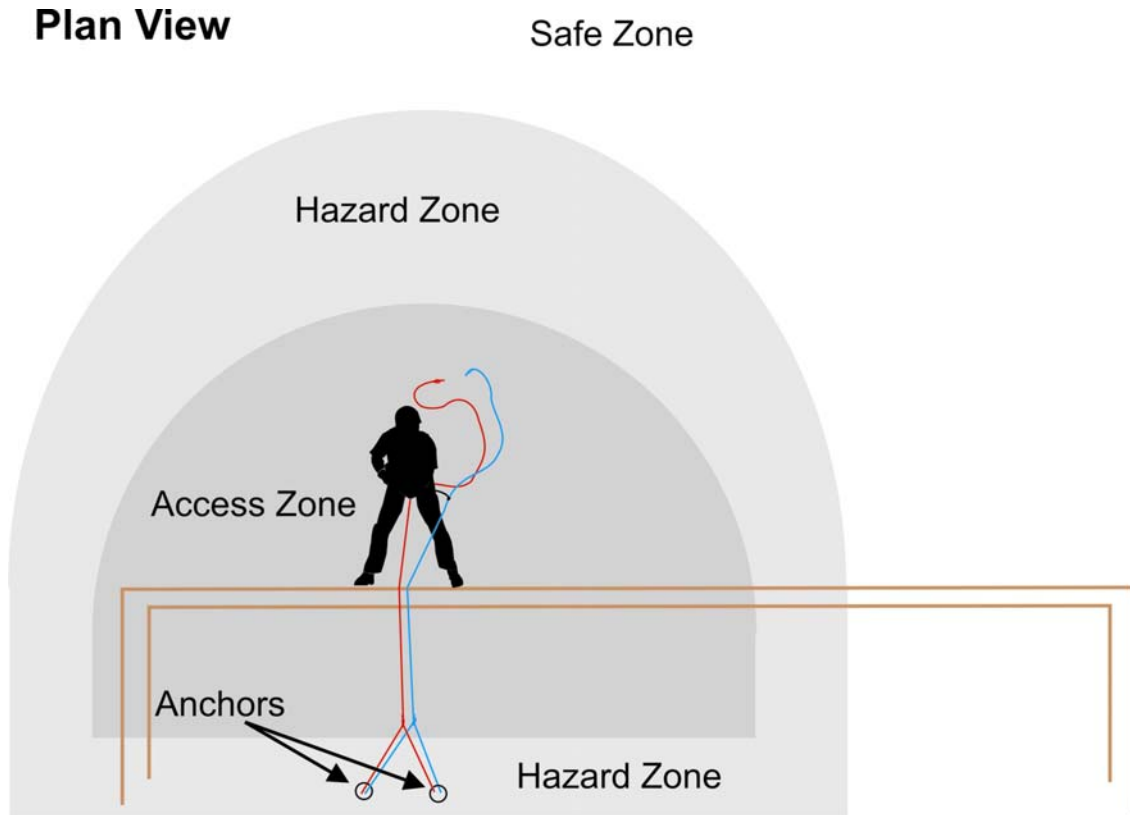
The Safe Zone is an area outside the direct influence of the rope-access operation. The Safe Zone must be designated well beyond the potential Hazard Zone, since dropped or dislodged items may bounce considerably farther than might be expected.

Teams may use red "Danger, Do Not Enter" tape to cordon off the controls, or yellow "Caution" tape to isolate the access or hazard zones. Generally, red tape means: "do not enter". It must be accompanied with a notice clearly prohibiting entry. This notice shall identify who must be contacted before the tape can be crossed.



**Figure 4-3. Work Zones**





**Figure 4-4.** Plan View of Work Zones

**Safety Checks**

Before beginning or proceeding with rope-access work, systematic safety checks must become a habit. The technician is responsible for doing these checks prior to entering the access zone. A co-worker must also perform these checks whenever possible.

Below is a list of safety checks that must be performed before entering the Access Zone. The acronym **RH<sup>3</sup>** can be used to help remember the fundamentals...

- Ropes:** Check ropes, knots, anchors, edge protection
  - Ropes are in good shape and not twisted
  - Knots are appropriate, properly tied, tightened, and with sufficient tails
- Harnes:** Properly fit, fastened, and connected
  - Buckles threaded properly
  - Fitted snugly
  - Screw links and other connectors coupled
  - No obvious damage to harness
- Helmet:** Properly fit and fastened?
  - Anchors are sound
  - Edge protection is in place



**H**ardware: Connectors locked and devices checked for function

- Connectors are actually squeeze-tested to insure that they are locked.
- Descender threaded properly and checked for function
- Ascenders attached properly to harness and tested for function
- Back-up device functional and properly attached.

In addition to the RH<sup>3</sup> fundamentals, the following may also need to be checked.

- Is extra gear (descenders, ascenders, footloops, runners, prusik loops, etc.) properly stowed so that the worker will not become entangled?
- Are lanyards twisted around each other, under the worker's legs, or parts of the harness such that they may cause difficulty?
- Are the worker's clothes appropriate for the conditions?
- Are lights and communication devices adequately tethered to the worker?
- Radio Check – all members of team?

### **Accident Prevention & Rescue**

Accidents and the subsequent need for rescues are usually the result of poor planning, bad habits, or shortcuts. Safety must become part of every action taken by a rope-access technician.

The focus on accident prevention, however, doesn't relieve the employer or team member from the responsibility of preparing a detailed rescue plan in the event of an emergency. The Rescue Plan must be considered thoughtfully and shared among all the team members and other affected parties. Practice of the rescue prior to beginning work is always recommended.

The Rescue Plan is covered in detail in Chapter 11.





## Chapter 5. Equipment

A thorough understanding of the proper use and limitations of equipment is necessary to develop safe work practices. Equipment used in life-safety systems is designed to withstand forces far in excess of those experienced in typical work situations. However, failure can occur under substantially smaller loads if used improperly.

### Equipment Inspection and Documentation

Proper documentation of origin, use and inspection of equipment is necessary to insure the integrity of rope access systems. The following guidelines should be followed.

- Designate an equipment manager for the purpose of overseeing the care, storage, documentation, and replacement of equipment.
- Keep all manufacturer's instructions and lot identification tags.
- Mark equipment so that it can be uniquely identified, but does not compromise equipment operation or integrity.
- Record equipment usage with notes regarding extreme or abnormal conditions of use.
- Immediately remove from service any equipment with signs of deterioration or excessive wear, or if it has exceeded manufacturer's recommended work life.
- Visually inspect equipment before and after each use.
- Have equipment thoroughly inspected and documented by a competent person periodically (based on frequency of use).

### Care, Storage and Transport of Equipment

Rope access equipment must be stored in a dry location away from possible chemical contamination or direct exposure to sunlight. Damp or wet equipment must be hung up to dry. Dry equipment can be stored in bags, boxes, or lockers.

Whenever possible, equipment bags or cases should be used to transport the equipment to protect it from contamination by chemicals or exposure to excessive sunlight. Table 5.7 outlines how to inspect, maintain, and mark rope-access equipment.

### Personal Protective Equipment (PPE)

Personnel must wear personal protective equipment (PPE) as warranted by the jobsite conditions or requirements. This may include, but is not limited to:

- proper clothing
- proper footwear
- gloves
- safety glasses (and keepers)
- respiratory protection
- ear protection
- knee pads
- helmets

### Clothing

Appropriate clothing must be considered an integral part of your protective equipment. Clothing should provide adequate protection from environmental hazards (sun, weather, chemicals, sharp edges, etc.) while allowing mobility and ventilation. Clothing needs to be loose enough to allow full mobility, while not posing the hazard of becoming caught in safety equipment or work tools.



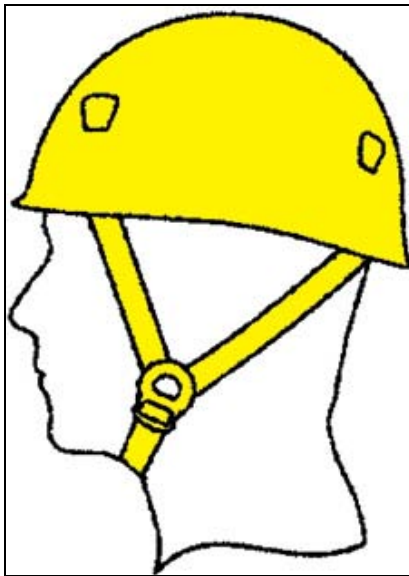
**Note:** Only carry light items in pockets and zip them up. Only use pockets that close securely!

### Footwear

Sturdy work boots with a flexible sole and proper heel are recommended for most rope-access work. Some facilities may require steel-toed boots. Soles with sticky rubber can be chosen to provide better footing when climbing around on a structure.

### Gloves

Gloves are recommended for most rope access work. Gloves must fit well and must not hinder the technician's ability to operate his tools and safety equipment.



**Figure 5-1.** Industrial Climbing Helmet

### Helmets

Helmets used for rope access must meet or exceed the appropriate ANSI standard (Z 89 Type II, Class C). The industrial climbing helmet (Figure 5-1) must have a three-point integrated harness system designed to secure it in place in the event of a fall. Standard hard hats are often not suitable for work at height because most hard hats are designed to protect the user

from the impact of falling objects only and do not have a reliable means to secure the helmet in place. Additional requirements may be met if electrical insulation is needed on the job site. At present, very few industrial climbing helmets are rated for electrical protection.

The helmet must be adjusted properly with the chin strap affixed and snug at all times when personnel are in the Hazard or Access Zone or are part of the rope access system (e.g. belaying). Helmets or approved hard hats shall be worn whenever and wherever the host facility requires them.

### Harnesses

The harness is a worker's most fundamental link to his safety system. With some exceptions, harnesses suitable for industrial rope access must be a full-body design (or integrated chest and seat harness). The harness must meet ANSI Z359.1 and other relevant standards for its intended use.

The basic *fall arrest harness* is designed to be employed only in the event of a fall and is not comfortable or functional for work-positioning applications. In contrast, a *multi-purpose harness* (Figure 5-2) suitable for rope access should be comfortable when the worker is suspended and have additional attachment points to perform the work.

A multi-purpose harness will often have waist, sternal, dorsal, and lateral attachment points. Connections to back-up and fall-arrest systems should be attached to the harness above the waist (sternal or dorsal).





**Figure 5-2.** Multi-purpose harness w/chest ascender attached

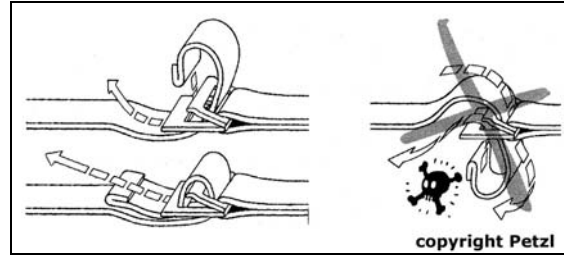
The dorsal attachment point has the disadvantage of creating a difficult self-rescue situation if the worker is caught suspended from it. Work-positioning connections can be made to the waist, sternal, and lateral attachment points.

Lateral attachment points must be used in pairs when used for work positioning!

The harness must be adjusted snugly while not restricting full freedom of movement. It should be comfortable for its intended use, but not so complicated

as to interfere with the worker's task. Generous gear loops on the harness are necessary when working while suspended on rope.

Follow manufacturer's instructions for wearing and securing the harness.

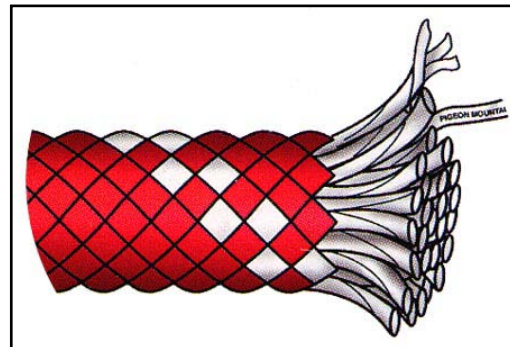


**Figure 5-3.** Correct threading of buckle on some harnesses.

Doubling back through all the buckles on harnesses is absolutely critical! Not doubling back can cause the failure of the harness and the entire life-safety system.

**Ropes**

Rope used for rope access must be made of synthetic fibers (e.g. nylon and polyester) and be of "kernmantle" design (Figure 5-4). Kernmantle ropes are composed of an inner core (kern) wrapped by a woven nylon sheath (mantle). The core contributes to the majority of the rope's strength while the sheath serves primarily to protect the core.



**Figure 5-4. Kernmantle Rope** (copyright PMI)



The construction, configuration, and choice of rope materials can dramatically affect the performance and handling of the rope. Ropes must be carefully chosen to meet the safety and practical requirements of the task.

Standard ropes used in rope-access work must measure 3/8-1/2 inch (10-12.5 mm) in diameter. Ropes commonly come in 660 ft (200 m) spools; however, custom lengths can be ordered or cut to meet nearly any job requirement.

All ropes used for the purpose of rope access must have at least a minimum breaking strength of 6,000 lbf (27.3 kN).

Ropes are often classified into two broad categories, based on the elastic qualities of the rope – *low-stretch*, and *dynamic*<sup>1</sup>.

**Low-stretch** (or “static”) ropes are most common in rope-access applications and are recommended for use as working and safety lines in most situations. Generally, workers will be attached to ropes directly overhead (without slack) and any force generated during a fall will be transferred immediately to the rope, eliminating the need for a dynamic rope.

**Dynamic** ropes are used in rope access only when needed to absorb high impact forces anticipated as a result of a significant fall (e.g. lead climbing). To minimize the impact forces generated in a fall, dynamic ropes will stretch up to 30% before failure. Dynamic ropes must be chosen if the fall factor anticipated could exceed 0.25. (discussion of fall factor in Chapter 8).

<sup>1</sup> The Cordage Institute also defines *static* ropes, in addition to *low-stretch*, and *dynamic* ropes. “Static” rope is considered by some to be a misnomer since all rope stretches. When purchasing or using a life-safety rope, it is more important to understand its unique attributes than the terminology used to define it.

**Table 5-1.** Characteristics of Dynamic & Low-stretch rope

Rope Type	stretch (loaded to 10% of MBS)	Best use
Low-stretch	0-10%	Working and Safety Rope
Dynamic	Usually more than 10%	Lead rope

**Caution! The possibility of a falling worker striking obstacles below due to rope stretch is a serious consideration when using any rope, especially one with substantial elastic properties.**

### Washing rope

Ropes should be washed periodically with tepid water and mild detergent, either in a wash basin, front-loading commercial washing machine (to avoid agitator of top-loader), or with a commercial rope cleaning device, then hung out to dry in a shaded location. Remember to replace any identification markers if necessary.

### Retirement

Worn or damaged portions near the ends of the rope can be cut off using a hot knife (mark rope appropriately to reflect new length of rope). Otherwise, ropes showing any of the above signs of wear or which sustain a significant shock-loading event shall be retired immediately. Length of service will depend greatly on frequency and type of use. See Table 5-2 for general guidelines. A logbook documenting the conditions, duration, and frequency of use is important.

### Rope Marking and Documentation

Each rope must be clearly marked on at least one end with a unique alpha-numeric



code for identification, inspection and documentation purposes. Heat shrink tubing can be used to protect the marking. The following coding protocol is recommended:

- Rope type/brand**
- Diameter**
- Length**
- Unique tracking number**
- Date in service**

Note that the inks in some markers can damage rope and slings. Generally, it is not the solvent in the ink, but trace elements such as phenol in the inks that are known to damage rope yarns.<sup>2</sup>

**Table 5-2. Rope retirement schedule**

<b>Duration of Use or Event</b>	<b>Retirement Schedule</b>
Any of the listed signs of wear	Immediately
Shock loading event	Immediately
Daily	No more than 1 year
Once per week	No more than 2 years
Occasional	No more than 5 years (less if manufacturer's recommendation)

**Connectors**

Connectors are a class of metal links used to connect the components of life-safety systems. Carabiners, screw-links, and scaffold hooks are the main types of connectors used in rope-access and fall-protection systems. Connectors are fabricated from steel, aluminum, and various alloys.

Steel connectors are the most common in industry because of steel's durability, strength, and relative low cost.

Aluminum is chosen for its high strength-to-weight ratio, yielding connectors that are considerably lighter than steel.

<sup>2</sup> For a complete discussion on this topic refer to an article on the SPRAT web page at: [http://www.sprat.org/memberAdmin/documents/newsletters/Fall\\_03/index.htm](http://www.sprat.org/memberAdmin/documents/newsletters/Fall_03/index.htm)

**Table 5-3. Polyester vs. Nylon Ropes**

<b>Polyester (Dacron™ Dupont)</b>	+	<ul style="list-style-type: none"> <li>• Similar strength when wet or dry</li> <li>• More acid resistant than nylon</li> <li>• Low elongation (0.7% with 300 lb mass with HTP)</li> </ul>
	-	<ul style="list-style-type: none"> <li>• Low elongation</li> <li>• Alkali degradation</li> </ul>
<b>Nylon (most common)</b>	+	<ul style="list-style-type: none"> <li>• 10% stronger than polyester (by weight)</li> <li>• Good at absorbing forces</li> <li>• Resistant to many chemicals</li> </ul>
	-	<ul style="list-style-type: none"> <li>• 10-15% weaker when wet</li> <li>• Acid and bleaches can damage rope</li> </ul>

Aluminum connectors are more susceptible to stress fractures following impact, and will wear quickly when connected to steel (e.g. aluminum connector attached to steel cable on horizontal life-line). Aluminum is often avoided in highly combusive environments because it has a hotter spark potential when struck against steel. Despite their limitations, aluminum connectors are often chosen by personnel that work in light-duty applications where ease of mobility is a requirement (e.g. inspections).

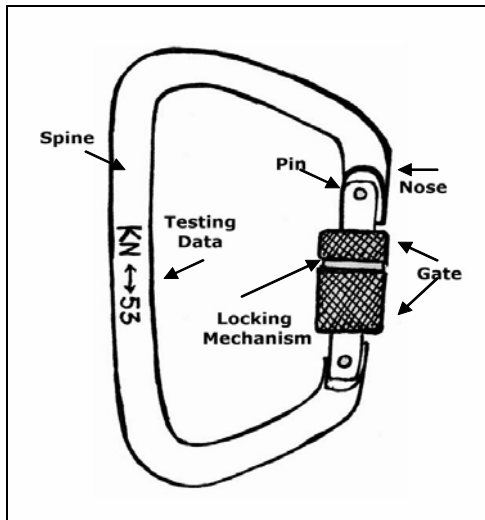
**Carabiners**

Carabiners used in rope-access systems must be outfitted with a positive locking mechanism and have a minimum breaking strength of not less than 5000 pounds (22.2 kN) when tested in the manner of function. Non-locking carabiners can be used for any attachment outside of the life-safety system. (e.g. clipping tools, etc.) See Figure 5-5 for common terminology of carabiner parts.



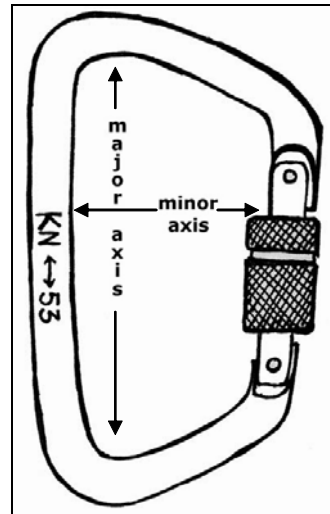
Material	Positive (+)
Aluminum	<ul style="list-style-type: none"> <li>• Light weight --</li> <li>• Higher strength-to-weight ratio</li> </ul>
	<p><b>Negative (-)</b></p> <ul style="list-style-type: none"> <li>• Sometimes more expensive</li> <li>• Hotter spark potential</li> <li>• Can wear quickly or get damaged when connected to steel</li> <li>• More susceptible to stress fractures when dropped</li> </ul>
Steel	<p><b>Positive (+)</b></p> <ul style="list-style-type: none"> <li>• Less susceptible to wear and damage when dropped or connected to other steel components</li> <li>• Usually less expensive</li> <li>• Lower spark temperature</li> </ul>
	<p><b>Negative (-)</b></p> <ul style="list-style-type: none"> <li>• Heavy – Lower strength to weight ratio</li> </ul>

**Table 5-4. Characteristics of Aluminum and Steel Carabiners**



**Figure 5-5. Terminology of Carabiners**

The breaking strength of a carabiner is affected by many factors including the orientation of the load and the configuration of the carabiner and adjacent components. Some of the concerns described within this section can catastrophically affect the integrity of a life-safety system, while others may be purely academic, depending on the situation. Experience and knowledge of system dynamics can help determine the relative importance of each concern. Avoiding improper loading of carabiners altogether is the best policy. The role of carabiners in system dynamics is also treated in Chapter 8 – System Analysis.



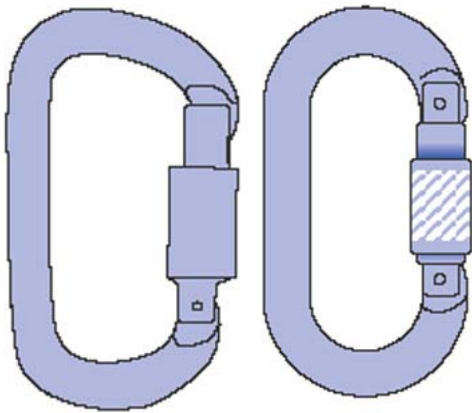
**Figure 5-6. Minor and Major axis of Carabiners**

Carabiners are designed to be loaded along the major axis. They must not be loaded along the minor axis (Figure 5-6). A carabiner loaded along the minor axis can fail at less than half its major axis strength. It is strongest when the load is placed closest to the solid spine and furthest from the weaker gate.

**Carabiner shape** plays an important role in determining carabiner strength and appropriate use. A D-shaped (or modified D) carabiner is the strongest because it accepts a load directly along the spine (Figure 5-7) of the carabiner.



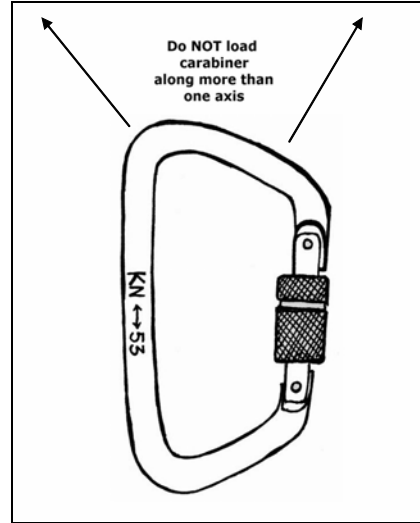
The oval, by contrast, is the weakest design because the load is shifted toward the gate. The oval, however, is a convenient shape because it centers the load on devices, such as pulleys and rope grabs, and will not compress them against the spine of the carabiner. Most carabiners in use are modifications of the D or Oval.



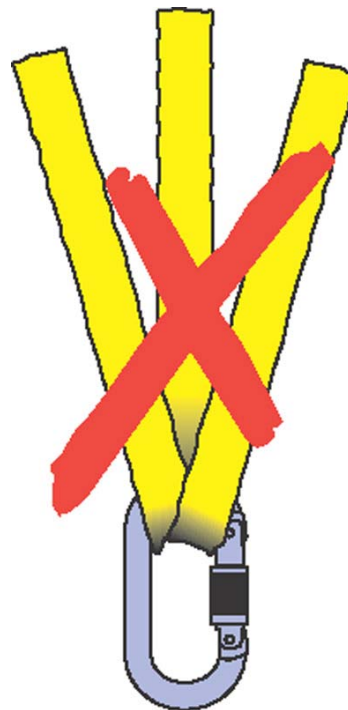
**Figure 5-7.** A D-shaped carabiner (left) and an oval carabiner (right)

Carabiners can also fail below their design strengths when loaded under the following conditions.

- Gate open – metal stock of carabiner will want to return to its original unbent shape when the latch is not engaged. Note: Some locking mechanisms can prevent the gate from closing properly (see Figure 5-7)
- Along more than one axis simultaneously
- Overloaded with several slings or wide slings – load will be distributed away from spine (Figures 5-9)
- Loaded over an edge
- Chain-linked carabiners – twisting forces may result especially when 3 or more carabiners are linked and loaded against a surface.

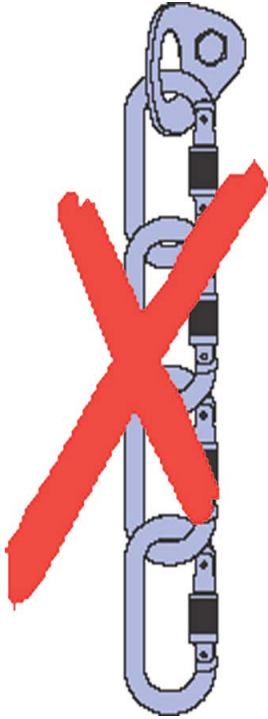


**Figure 5-8.** Loading carabiner along more than one axis.



**Figure 5-9.** Overloaded Carabiners



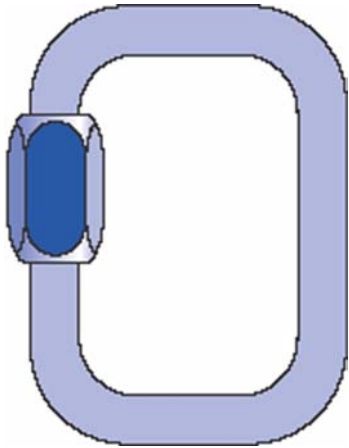


**Figure 5-10:** Do not Hard-link Carabiners

**Table 5-5. Attributes of Various Connectors**

<b>Gate opening type</b>	<b>Number of steps to open</b>	<b>Attributes</b>
Non-locking	1-step	Light-weight and easy to open. Can be used for clipping tools or accessories Not appropriate for life-safety applications
Screw lock (carabiner)	2-step	Easy to operate with gloves Takes multiple rotations to unlock Does not lock automatically Must be checked regularly; can unlock inadvertently or prevent gate from closing properly
Quick-lock	2-step	Easy and quick to operate with gloves Locks automatically It is possible to unlock and open inadvertently
3-step	3-step	Some models awkward to operate with gloves Often expensive and heavy Most secure
Lever-lock (Scaffold hook)	2-step	Easy and quick to operate Large gate opening Usually has a weak gate
Screw sleeve (Quick-link)	Not applicable	Secure and strong when tightened well Link is very weak when sleeve unscrewed May need wrench to unscrew



**Quick-links (maillons)**

Quick-links close by screwing down the sleeve. Some quick-links are designed to take loads in multiple directions, making them more suitable than carabiners for specific applications. Quick-links are usually less expensive, sometimes more secure, and often more durable than carabiners. Despite their name, quick-links are often not as quick or convenient as carabiners.



**The strength of the quick-link depends on the sleeve being screwed down completely!**

The quick-link closure is quite secure and can be even more secure when tightened

with a wrench. The wrench may also be needed to loosen even hand-tightened quick-links. The sleeve should also be screwed down completely when not in use to protect the threads.



**Caution! Not all quick-links are suitable for life-safety applications.** Standard hardware store quick-links are usually not certified for life-safety applications!

**Lanyards and Energy Absorbers**

Lanyards are short, flexible connections between the worker's harness and an anchor or mobile attachment point. An energy absorber may be integral to the lanyard design or added, as needed, per manufacturer's instructions. Lanyards differ depending on whether they are used for work-positioning (including rope access) or fall-arrest applications.

Lanyard length must be chosen to limit the distance of the potential fall onto the lanyard. The optimum lanyard length is 3 feet (1 m) or less in order to insure that the potential fall does not exceed 6 feet (2 m). Lanyards of up to 6 feet (2 m) long are allowed provided they are attached to an anchor higher than the worker's chest level.

**Fall-arrest lanyards** with shock absorbers (Figure 5-11) must be used if a fall of more than 2 feet onto a fixed anchor can occur. Fall arrest lanyards must be attached to the dorsal or sternal attachment point and include an energy absorbing system that limits the maximum impact force felt by the falling employee (specified by OSHA) to 1760 lbf (8 kN).<sup>3</sup> Energy absorbers dissipate the forces generated during a fall by tearing stitching designed for this purpose. The maximum length of the fully deployed

<sup>3</sup> Note: Lanyards connected to mobile fall arrestors and back-up devices usually do not need an energy absorber because most of these devices are designed to absorb some of the forces generated in a fall by slipping before arresting the fall.

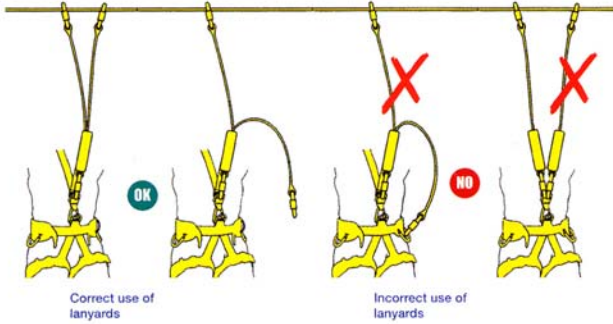




energy absorbing lanyard must not exceed 39 inches.



**Figure 5-11.** Shock-absorbing lanyard

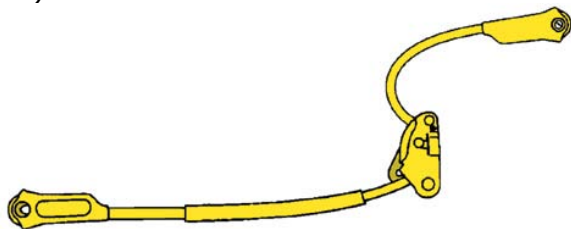


**Figure 5-12.** Proper use of Y-lanyard

The leg of Y-lanyard that is not in use must be left hanging or clipped to the anchor (directly or indirectly), but must not be clipped back to the harness where it would interfere with deployment of the energy absorber.

**Work-positioning Lanyards**

A variety of lanyard types are available for work positioning. Unlike those designed for fall-arrest, work-positioning lanyards usually are not fitted with an energy absorber. These lanyards are designed to be used in tension that limits the potential free fall to less than 2 feet (0.6 m) if the primary work-positioning system fails. Lanyards with built-in adjustment devices are useful for work positioning (Figure 5-13).



**Figure 5-13.** Work-positioning lanyard with integral adjustment device.




**Rope-Access Lanyards**

Rope access technicians generally use 2-3 lanyards or “cow’s tails” made from dynamic rope for a variety of applications. These lanyards are often connected to the central waist connection with a square screw link. Pre-manufactured lanyards with fixed terminations can be purchased.

Alternatively, lanyard terminations for rope access can be created using a barrel or figure 8 knot (See Chapter 6).

Because work positioning lanyards do not have energy absorbers, they must not be used in fall arrest applications. Fall arrest lanyards, however, can be used in work positioning applications.

Fall-arrest lanyards must be attached to the sternal or dorsal connections of the worker’s harness while work positioning lanyards can be attached to the waist, sternal, or lateral connections<sup>4</sup>.



**Remember to always connect lanyards as high as possible to minimize the potential fall factor and impact force.**

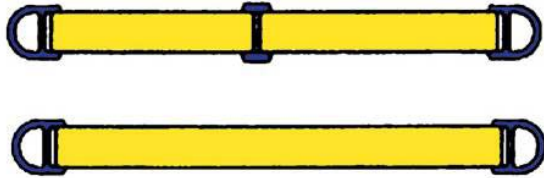
<sup>4</sup> Note: Currently OSHA, ANSI, and USBR standards specify the use of the dorsal attachment point for *fall arrest* applications. Sternal attachment is allowed in some circumstances. The clearest advantage of using the sternal attachment point is the ability of employees to rescue themselves in the event of a fall.



**Synthetic Fiber Slings and Straps**

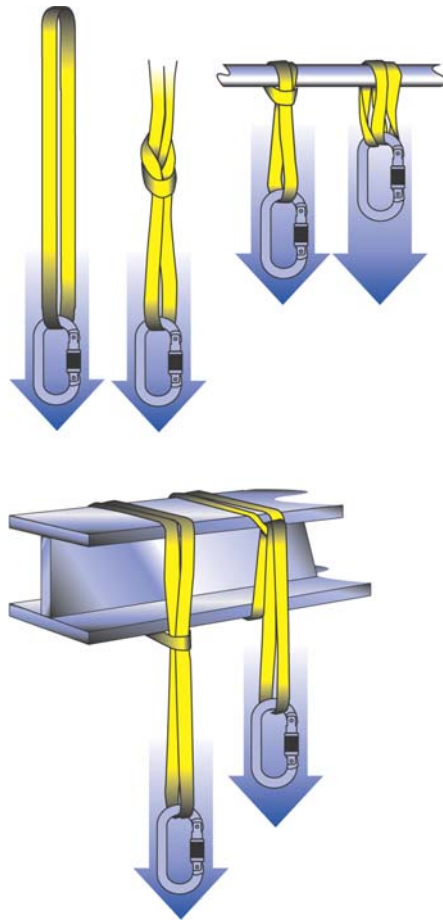
Textile straps used for industrial purposes must be made of synthetic fibers (i.e. nylon and polyester) and yield a strap rated for at least 5,000 pounds (22.2 kN).

Various configurations and lengths can be fabricated from synthetic webbing.



Loops and terminations should be sewn -- not knotted. A simple overhand knot can be placed in a sling to help configure an anchor provided it does not weaken the connection to below 5,000 lbs (22.2 kN).

Precautions must always be taken to avoid contact of webbing and nylon straps with sharp surfaces, petroleum products, and other chemical contaminants. Closed cell foam padding, commercial rope protectors, retired fire hose, or other buffering materials should be utilized.



**Figure 5-14.** Various configurations of industrial slings (clockwise from upper left) End to end, knotted sling, girth hitch, basket, tensioning girth hitch, non-tensioning girth hitch.

**Table 5-6. Minimum breaking strength of synthetic fiber slings**

Material	End to End	Basket	Basket (H-beam)	Girth Hitch non-tensioning
1" Type 18 Webbing sewn loop	9,744 lbf 43.5 kN	20,500 lbf 91.5 kN	11,088 lbf 49.5 kN	7,392 lbf 33 kN
9/16" Spectra Webbing sewn loop	6,384 lbf 28.5 kN	13,238 lbf 59.1 kN	7,952 lbf 35.5 kN	4,524 lbf 20.2 kN

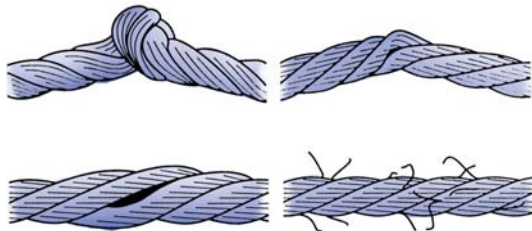




### Wire Rope Slings

In many industrial situations, the use of wire rope slings for establishing anchorages is more practical than synthetic fiber slings. Wire rope is more resistant to damage from sharp edges, chemicals, or heat.

Wire rope slings used in life safety applications must yield a minimum breaking strength of at least 5,000 lbs (22.2 kN). Wire rope of 5/16" (9 mm) diameter is most common. Swages (ferrules) are used to create soft eyes on either end, allowing the sling to be used end-to-end, in basket configuration, or choked (girth-hitched).



**Figure 5-15.** Typical damage found on wire rope slings. Clockwise from top left: Kinking, crushing, fraying, bird-caging.

### Edge Protection

Software (ropes and slings) used in industrial life-safety applications are especially strong; however, damage and catastrophic failure can occur easily if care is not taken to protect software from sharp or abrasive edges and contaminates. Edge protection is as much a technique as it is a class of specialized equipment designed to protect ropes and other software.

### Goals of edge protection

- **Protect the rope:** The most important goal is to protect the rope from sharp, abrasive, or hot surfaces.
- **Protect the surface:** Taking care not to damage the structure is not only a matter of keeping the facility owner happy. Breaking fragile building facades, hand rails, or light fixtures can create a new sharp edge hazard under the tensioned rope or cause injury to people below as broken pieces fall to the ground. Care must also be taken to prevent loose rocks and debris from falling from the top.
- **Reduce friction:** If tensioned ropes need to move over edges or abrasive surfaces it becomes important to consider methods to reduce friction in order to protect the ropes and the surface while completing the task efficiently.
- **Keep software clean:** Edge protection equipment and techniques can also be used to protect software from foreign substances such as grease, chemicals, and other contaminates.



### Types of Edge Protection

Equipment used for edge protection on the job site can be broken down into two classes: (1) Simple Edge Protection and (2) Friction-reducing Edge Protection. Friction reduction can be achieved using a sliding surface, or more efficiently with a rolling surface. Equipment, tools, and techniques can be combined or improvised on the job site to achieve a variety of results.

### Simple Edge Protection

The most common forms of edge protection are *edge pads* and *rope guards*.

Lab testing and field experience has shown that canvas is the most effective and versatile material to use for this purpose. Nylon carpet, rubber mats, and other synthetic materials may actually damage ropes by the heat generated from the friction of moving ropes!



**Figure 5-16.** Ultra-Pro Edge Protector - available in 2-rope model. (CMC Photo).

### Friction-reducing Edge Protection

When tensioned ropes must move over rough surfaces or edges it becomes important to choose edge protection that reduces friction. This is achieved by either providing a *sliding surface* or introducing a *rolling surface*.

A *sliding surface* is usually created by inserting round metal stock, or specially designed plastic (e.g. Ultra-Pro edge protectors). The Ultra-Pro edge

protectors (Figure 5-16) are perhaps the most versatile and convenient form of edge protection because they are light-weight and the rope is least likely to slip off the protector.

A *rolling surface* can be provided by edge rollers, roof rollers, or pulleys. Using a rolling surface is substantially more efficient than using a simple sliding surface; however the challenge with using most of these devices is keeping the rope from shifting laterally and eventually coming off of the roller. Rolling devices can be managed effectively with care and should be used where appropriate.

Several effective techniques for managing edges, including using a change of direction (deviations), or intermediate anchors (rebelays), are further described in Chapter 9, Technique.



### Belay Devices

Belay devices are used to adjust the slack in the rope between a moving worker (climber) and another person (belay), stationed at a fixed anchor. This process of securing the climber is referred to as an *attended belay* and is covered in more detail in Chapter 9. Self-belay using a backup device is more common. Attended belaying is still required during some traversing and lead climbing operations, and is preferred when the worker on rope needs to have his hands completely free to manage other tasks.

Although many types of belay devices exist in the recreational market, devices



with self-locking mechanisms are recommended for industrial use.

Many belay devices can also function as descent control devices. However, not all descent control devices are appropriate for use as belay devices! Use of a "self-locking" belay device does not exempt the belayer from using proper belay technique. Self-locking devices serve only as an additional safety measure and must not be relied upon to stop the climber in the event of a fall.

### **Descent-control Devices**

Descent-control devices (or descenders) provide a means to descend at a controlled rate. Descenders can be operated by the user as a *traveling brake*, or operated by a second person as a *fixed brake* attached to an anchor.



**Figure 5-17.** Auto-braking Descenders: Petzl I'D (left) and Petzl Stop (right)

Descenders used in industrial applications should have a self-braking capability, either built into the design of the device, or added afterwards by the user. The Petzl I'D and Stop (Figure 5-16) have an auto-braking mechanism, while the rappel rack (Figure 5-17) does not. A prusik or rope grab can be added below a rappel

rack to create the hands-off self-braking capability.



**Figure 5-18.** SMC Rappel Rack with brake bar tie off

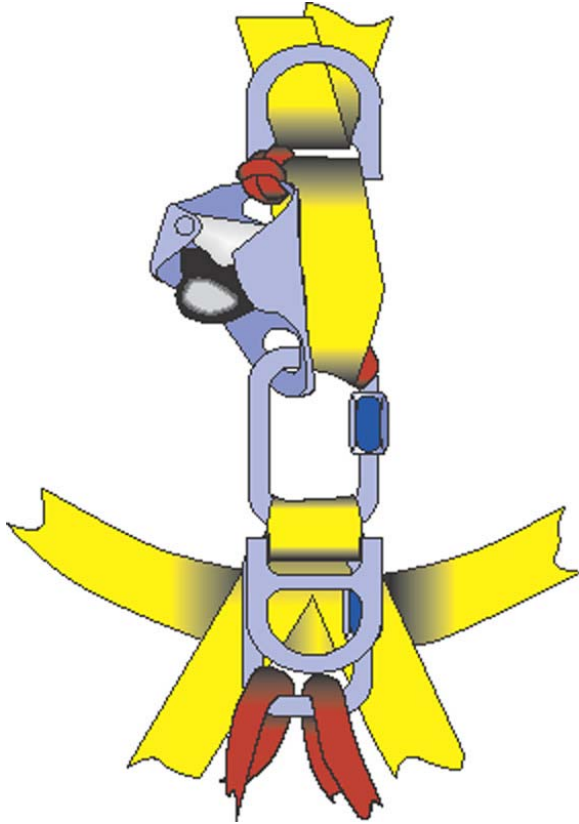
### **Rope Grabs**

#### **Ascenders**

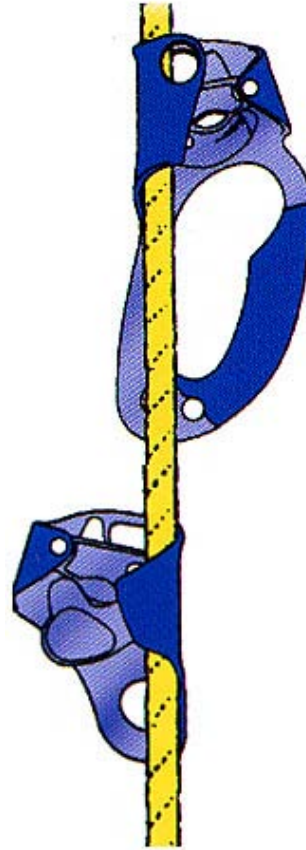
Ascenders (Figure 5-20) are rope grabs designed to be used to climb a rope. Ascenders are generally used in pairs. This type of rope grab is usually equipped with relatively aggressive teeth to grip the rope even in muddy or icy conditions. Consequently, the rope grab will not slip if shock loaded. A dynamic fall onto an ascender with teeth will generate high impact forces and may damage or sever the rope entirely. Some harnesses are designed to integrate well with a chest ascender (Figure 5-19)

Ascenders are generally designed to be used on ropes that are deployed vertical or angles higher than 45°. Occasionally when ascenders are used in rope-to-rope transfers or negotiating loops, it is possible to load an ascender on very low angles. Rope-access personnel must take care to prevent the unintended detachment of such devices in low-angle loading situations (Figure 5-21). Most toothed ascenders are equipped with a secondary carabiner hole above the cam. A carabiner inserted into this hole prevents the ascender from detaching from the rope (Figure 5-22).

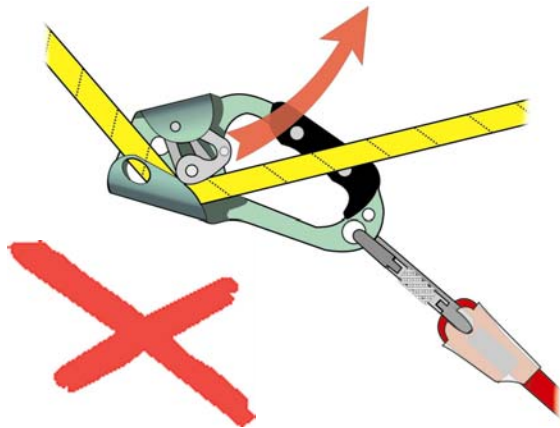




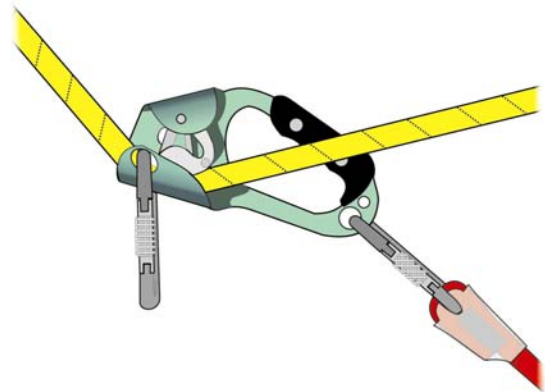
**Figure 5-19.** Chest ascender affixed to a harness



**Figure 5-20.** Hand and Chest Ascenders.



**Figure 5-21.** The cam of an ascender can become disengaged when the device is used on a low-angle rope

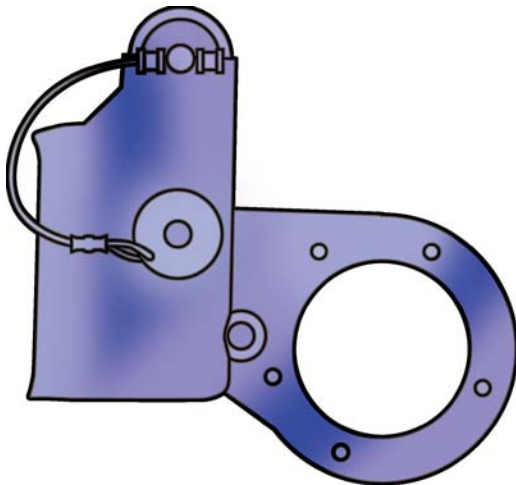


**Figure 5-22.** A carabiner placed in the upper hole of an ascender can prevent it from coming loose in low-angle applications



**Warning! Toothed ascenders are not designed to take a fall and may fail if subjected to shock-loading.**

**Self-trailing rope grabs** (a.k.a. fall arrest rope grabs) are designed to travel freely up and down the rope without manual manipulation by the worker. In order to meet the ANSI Z359.1 standard for conventional fall arrest applications, the device must pass a dynamic and static test, must be "self-trailing", and must not be defeated easily by the user. Field and lab testing by Ropeworks, Inc., and Reclamation has shown that an ANSI-labeled product is not necessarily safe in all field conditions and rope combinations.



**Figure 5-23.** MIO Rope grab for 7/16" or 1/2" rope (different models available).

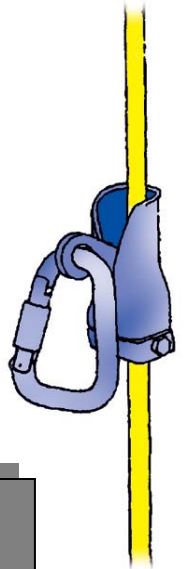
**Ascender-type rope grabs** generally employ a cam mechanism to clamp onto the rope. The device generally stays in place on the rope and is often moved up or down manually by the user. A short string attached to the device is usually employed to tow the device while descending. The advantage of this type of device for rope access is that the worker can usually keep the device high and out of the way of the work area thereby minimizing the distance of the potential fall if a failure were to occur.



**Figure 5-24.** Tractel Stopfor D for 7/16"-1/2" rope

However, manual manipulation of the device, especially during descent, poses a potential risk of failure. Most of these devices can be defeated inadvertently by the user. Obviously, thorough training is an integral component of the safe use of this type of back-up device.

The Petzl Shunt is the most common rope access back-up device in use world-wide. Please see Chapter 9 for proper use of back-up devices like the Shunt.



**Important! Be certain that the rope grab and rope combination is appropriate for your intended use.**

### **Pulleys**

Various friction-reducing pulleys are used in rope-access and rescue applications (Figures 5-25, -26, -27). Pulleys can be used to change the direction of the rope path, create mechanical advantage, or help guide equipment or personnel along a fixed line.

Pulleys come with *bushing* or *ball bearing* axles. Pulleys with ball bearings are generally more efficient (and more expensive). The larger the diameter of

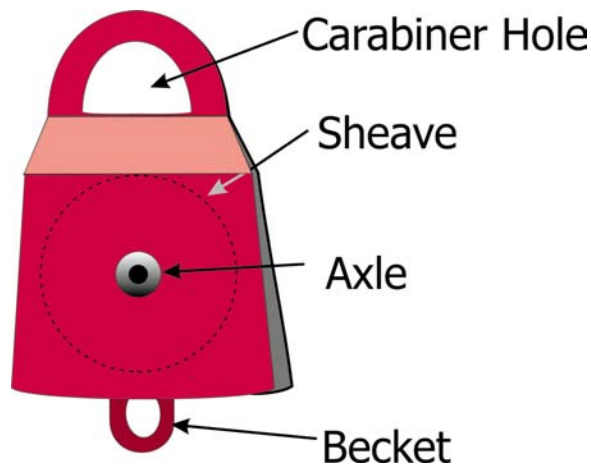


the sheave is, the more efficient the pulley.

The fixed cheek (or side-plate) pulley is the simplest design, however a rescue pulley with swiveling side-plates is most common (Figure 5-26). The Kootenay knot-passing pulley is used to allow knots in loaded lines to freely pass through device. It can also be used as a high-strength tie-off. The tandem pulley is used on highlines and tracking lines to avoid twisting and extra friction that is often created when single pulleys are used for this purpose.



**Figure 5-25.** Standard rescue pulley with steel swiveling side-plates.



**Figure 5-26.** Standard parts of a pulley



**Figure 5-27.** Assorted Pulleys (Clockwise from top left): Fixed cheek, standard rescue pulley, Kootenay knot passing pulley, and tandem pulley.

**Rigging plates**

Rigging plates (Figure 5-28) are useful whenever complicated rigging is required at an anchor point, especially during rescue operations. A rigging plate is designed to accept a load in multiple directions and therefore can be used to eliminate multi-directional loading on a carabiner connector.



**Figure 5-28.** Rigging Plate.





**Lights**

Additional lighting is an essential requirement of many rope-access jobs, especially in tunnels, penstocks, confined spaces, and industrial facilities. In most cases, a hands-free headlamp is the best solution for rope-access work. In some cases, a large hand-held light source is useful in addition to a headlamp (Figure 5-29).

The brightest on the market utilize a high-intensity discharge (HID) bulb, which produces a brilliant blue-white light while using far less battery power than a conventional bulb of the same brightness. Paired with a recharge-able nickel-metal hydride battery this combination can deliver up to four hours of intense light excellent for rope access work.

Spare batteries, bulbs, and perhaps even an additional headlamp should be carried where lights are required.



**Figure 5-29.** Typical Headlamp

**Equipment & Rope Bags**

An equipment bag is an essential part of a rope-access technician's tool kit. A good equipment bag is simple, durable and allows easy access to gear. It should be easy to carry up and down stairs or ladders.



**Table 5-7. Maintenance and Inspection of Software Components**

<b>Product</b>	<b>Care and Maintenance</b>	<b>Inspection and Retirement</b>	<b>Marking</b>
<b>All Synthetic Software</b> including nylon and polyester sewn webbing, harnesses, ropes, lanyards and shock absorbers	<ul style="list-style-type: none"> <li>• Avoid prolonged exposure to sunlight</li> <li>• Avoid chemical contaminants especially strong acids and bases</li> <li>• Protect from sharp and abrasive surfaces</li> <li>• Wash with mild detergent and warm water</li> <li>• Hang dry and do not store wet</li> <li>• Store in cool and dry location out of direct sunlight</li> </ul>	Retire immediately if shock-loaded or below signs of wear are noted. Check for: <ul style="list-style-type: none"> <li>• Unique identification</li> <li>• Abrasion, fraying, or tears in fabric or stitching</li> <li>• Fading, glazing, or unusual stiffness caused by heat, chemical contamination, or prolonged UV exposure</li> </ul>	Use indelible marker on non-load bearing components, tags, or tape
<b>Harnesses</b>	See above.	In addition to above check for: <ul style="list-style-type: none"> <li>• Wear, corrosion, cracks, and deformities of metal components</li> <li>• Proper function of buckles and connectors (see inspection of connectors)</li> </ul>	Use indelible marker on non-load bearing components (e.g. outside of padded waist belt).
<b>Ropes</b>	In addition to above: <ul style="list-style-type: none"> <li>• Avoid stepping on rope. Dirt and sand pushed through the sheath can damage the core.</li> <li>• Store only dry ropes coiled or stacked in rope bags.</li> <li>• Use edge protection and anchoring techniques to protect ropes from sharp and abrasive surfaces</li> <li>• Custom rope washers can be used</li> <li>• Daisy chain ropes before washing ropes in basin or front loading washing machine.</li> </ul>	In addition to above check for: <ul style="list-style-type: none"> <li>• Exposed core fibers or substantially worn sheath (50% of sheath fibers cut or abraded)</li> <li>• Inconsistencies in rope texture or stiffness: Soft spots, bulges, or obvious changes in diameter indicate core damage</li> </ul>	Use indelible marker on electrical tape and cover with heat-shrink tubing. A recommended marking system includes: <ul style="list-style-type: none"> <li>• Rope type</li> <li>• Diameter</li> <li>• Length</li> <li>• Unique ID number</li> <li>• Date in Service</li> </ul>
<b>Lanyards and Shock Absorbers</b>	See above.	In addition to above check for: <ul style="list-style-type: none"> <li>• Signs of dynamic loading including deployment of shock absorber</li> </ul>	See above.

**Table 5-8. Maintenance and Inspection of Hardware Components**

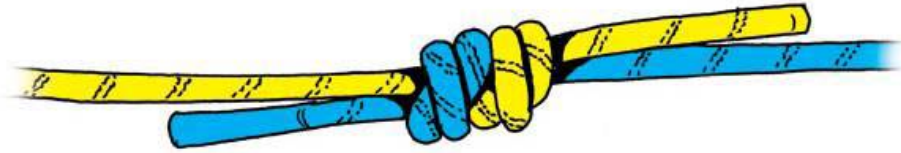
<b>Product</b>	<b>Care and Maintenance</b>	<b>Inspection and Retirement</b>	<b>Marking</b>
<b>All Steel and Alloy Components</b> Including connectors, descenders and rope grabs	<ul style="list-style-type: none"> <li>• Use keeper slings and good technique to avoid dropping while in use</li> <li>• Clean before inspecting</li> <li>• Lubricate with silicon or Teflon™-based lubricant as needed after inspection</li> <li>• Do not store wet</li> <li>• Store in dry environment</li> </ul>	Retire immediately if shock-loaded, dropped from 10 feet or above onto hard surface from or below signs of wear are noted. Check for: <ul style="list-style-type: none"> <li>• Unique identification</li> <li>• Hairline cracks and deep nicks</li> <li>• Deformation</li> <li>• Grooving from rope wear</li> <li>• Corrosion</li> <li>• Sticky or frozen mechanisms</li> <li>• Signs of shock-loading</li> </ul>	Light engraving on non-load bearing components
<b>Connectors</b> (carabiners and quick-links)	In addition to above: <ul style="list-style-type: none"> <li>• Lubricate carabiner gates and quick-link threads</li> <li>• Close quick-links before storing to avoid damaging threads</li> </ul>	In addition to above: <ul style="list-style-type: none"> <li>• Function of locking mechanisms</li> <li>• Look closely for cracking around pin and latches</li> </ul>	Engrave lightly individual ID on locking sleeves or create batch identification and inventory system using paint (avoid moving parts)
<b>Descenders</b>	In addition to above: <ul style="list-style-type: none"> <li>• Keep side plates of descenders closed when not in use</li> <li>• Ensure latch is fully closed before loading</li> </ul>	In addition to above check for: <ul style="list-style-type: none"> <li>• Wear of cam (the Petzl ID has a wear indicator)</li> <li>• Integrity of bolts, rivets, springs</li> <li>• Proper function</li> </ul>	Location of light engraving will vary by type
<b>Ascenders and Rope Grabs</b>	In addition to above: <ul style="list-style-type: none"> <li>• Keep latches closed while not in use to avoid accidental damage</li> </ul>	In addition to above check for: <ul style="list-style-type: none"> <li>• Condition of cam</li> <li>• Integrity of bolts, rivets, cables, and springs</li> <li>• Proper function</li> </ul>	Location of light engraving will vary by type
<b>Wire Slings</b>	See above.	In addition to above check for: <ul style="list-style-type: none"> <li>• Broken wires (especially around the swages)</li> <li>• Cracks and deformities in swages</li> <li>• Cable ends protrude beyond swage slightly (not more than 1/3 diameter of wire)</li> </ul>	Separate ID tag can be fitted. ID # can be engraved lightly onto swage



**Table 5-9. Maintenance and Inspection of Other Safety Components**

<b>Product</b>	<b>Care and Maintenance</b>	<b>Inspection and Retirement</b>	<b>Marking</b>
<b>Helmets</b>	<ul style="list-style-type: none"> <li>• Avoid chemicals, especially strong acids and bases, and avoid prolonged exposure to sunlight</li> <li>• Clean prior to inspection</li> <li>• Warm water and light detergent can be used</li> <li>• Store dry and clean away from contaminants and direct sunlight</li> <li>• Avoid rough handling that can scar or groove shell</li> <li>• Do not modify or alter shell or suspension in any way</li> <li>• Headlamps should be mounted only on compatible fixtures or straps</li> </ul>	<p>Retire immediately if helmet sustains an impact or is dropped from 10 feet or more onto hard surface. Check for:</p> <ul style="list-style-type: none"> <li>• Unique identification marking</li> <li>• Conformity to relevant standards (CE or ANSI Z89)</li> <li>• Cracks, dents or deep nicks in shell</li> <li>• Deformation of shell</li> <li>• Integrity of harness strapping system, buckles, and rivets anchoring it to the shell</li> <li>• Check to make sure suspension points are firmly snapped into place</li> </ul>	<p>Mark helmets with an indelible marker on harness, or on tape inside the helmet. Avoid using marker directly on shell. Especially avoid paint markers</p>





## Chapter 6. Knots & Hitches

Knots and hitches are indispensable tools for a rope-access technician.

Only appropriately trained personnel shall use knots in industrial applications. Sewn or swaged terminations (Figure 6-1) are often used as an alternative to knots because they are usually stronger and require less training to use. Factory-installed terminations, however, limit the adjustability of the connection to the rope.



**Figure 6-1.** Swaged Termination

Knots, or any tight bend for that matter, will weaken rope by as much as forty percent, depending on the knot used (Table 6-1). This, however, may be an academic point since ropes would be of little use without knots and safe working loads for ropes are usually figured at 10:1 to account for the decrease in strength attributed to knots.

The strength of knots is often expressed as a percentage reflecting the residual rope strength after the knot is introduced. The residual rope strength will depend on the type of rope and how it is tied.

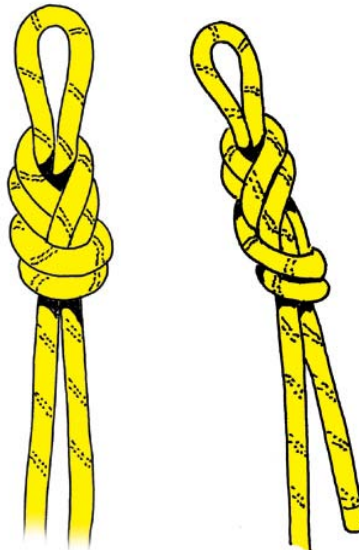
Cleaning up a knot and making sure to minimize twists and tight bends is called *dressing a knot*. A well-dressed knot is generally stronger and easier to inspect.

It is critical to use knots for their intended purpose. Some knots require a back-up knot, while most knots must be tied with at least 4 inches of tail.

### Common Knots and Hitches

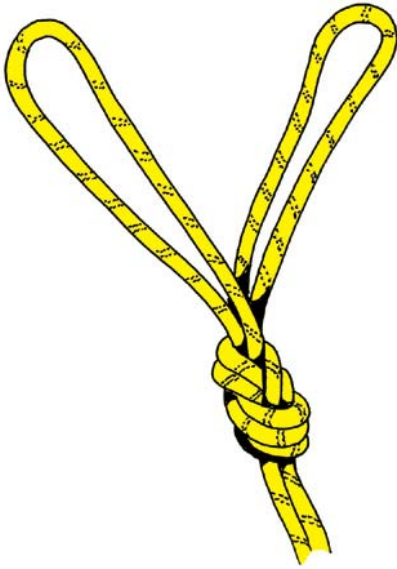
**Figure-8 knot** – a convenient and commonly used end knot that is easy to tie and inspect. The knot can be rethreaded and tied through a fixed loop, such as a harness D-ring.

**Figure-9 knot** – used to connect to a single anchor point. **Note:** The additional twist in the rope makes the knot stronger and easier to untie after loading, but more difficult to inspect.



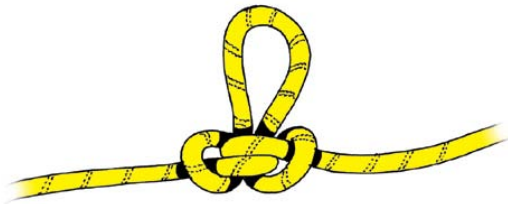
**Figure 6-2.** Figure 8 and Figure 9 knots

**Double figure-8** – used to connect or equalize two anchor points (a.k.a rabbit knot or bunny ears).



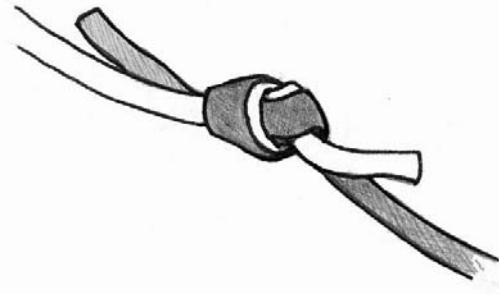
**Figure 6-3.** Double Figure-8

**Butterfly Knot** – a middle knot used to form a connection point or isolate a damaged section of rope. **Note:** If both ends of the knot will not be tensioned then a figure 8 or 9 is a better choice.



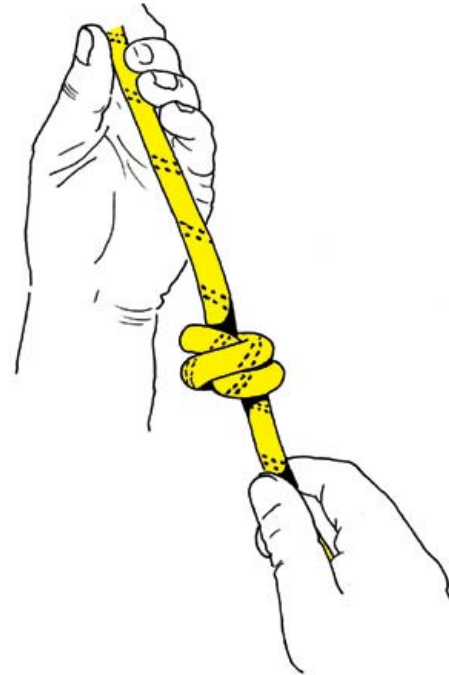
**Figure 6-4.** Butterfly Knot

**Water knot** (a.k.a. ring bend or tape knot) -- used to tie the ends of webbing together. **Note:** The water knot is susceptible to working itself loose through cyclic loading.



**Figure 6-5.** Water Knot

**Barrel Knot** – used as an end or stopper knot. **Note:** The barrel knot cinches down onto a carabiner if used as an end knot.



**Figure 6-6.** Barrel Knot

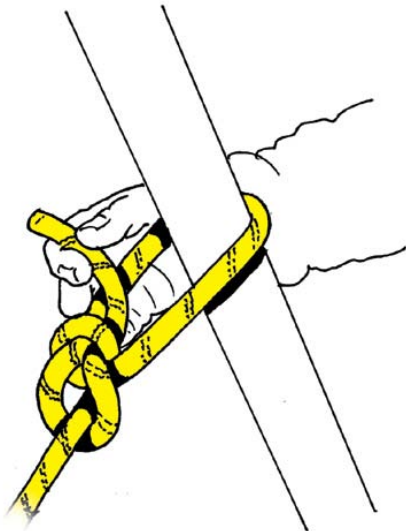


**Double fisherman’s knot** -- used to tie the ends of ropes or accessory cord together.



**Figure 6-7.** Double Fisherman’s Knot

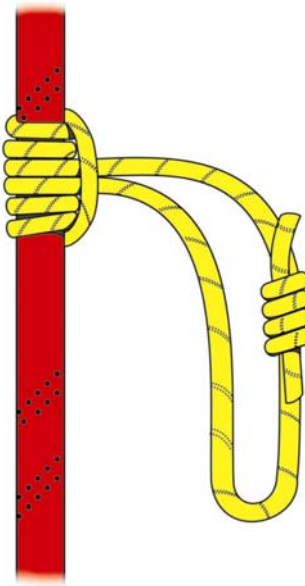
**Bowline** – an end knot useful when rope needs to be tied around a large object. Note: A bowline is not easy to inspect and can come loose if tied improperly.



**Figure 6-8.** Bowline Knot

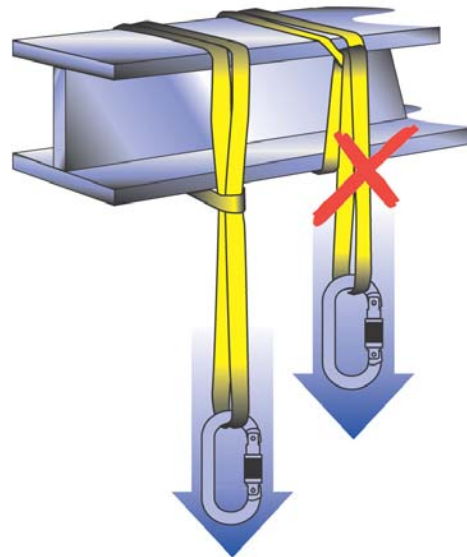
**Prusik** –a friction hitch that can be used as a rope grab on a tensioned line.

**Note:** A prusik loop is formed using about 5-6 feet of 7 or 8 mm accessory cord tied into a loop using a double fisherman’s knot. The prusik knot can be used as an emergency mechanical ascender, back-up device, and in various rescue situations. The strength of prusik knots varies considerably depending on the combination of rope and cord used. Prusiks should not be used in lieu of back-up devices in regular work applications.



**Figure 6-9.** Prusik Hitch

**Girth hitch**—used to create anchor points (Figure 6-10).

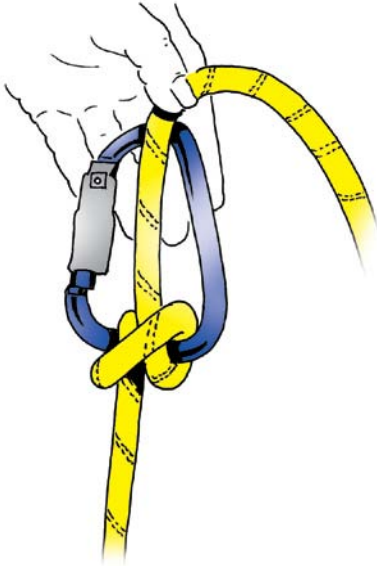


**Figure 6-10.** Girth Hitch. Note that tensioning girth hitches (right) weaken the connection considerably



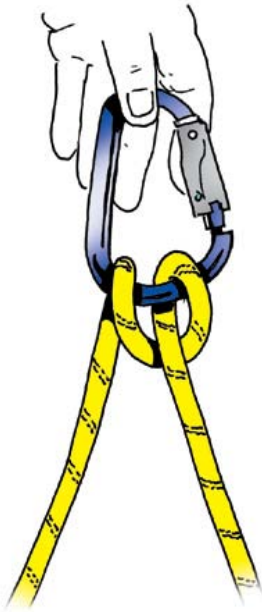
**Clove Hitch**—used to create an adjustable connection in various rigging applications. The load strand must be against the spine of the carabiner.

**Note:** Not generally recommended for industrial life-safety applications.



**Figure 6-11.** Clove Hitch

**Munter (Italian) Hitch** – is used as an emergency friction device in place of belay or descending device.



**Figure 6-12.** Munter Hitch

**Tensionless Hitch** – a friction hitch that maintains 100% of the rope strength when wrapped around a round member at least 4 times the diameter of the rope.



**Figure 6-13.** Tensionless hitch



**Figure 6-14.** Tensionless Hitch





**Mule Knot** – used to secure munter hitch, belay devices, and descenders.  
Note: The munter/mule knot combination creates a secure load-releasing hitch – a hitch that can be untied under tension. This is particularly useful for pre-rigging ropes for lowering operations. (see chapter 10).



**Figure 6-15.** Munter/Mule Knot: Step 1



**Figure 6-16.** Munter/Mule Knot: Step 2



**Figure 6-17.** Munter/Mule Knot: Step 3



**Figure 6-18.** Munter/Mule Knot: Step 4







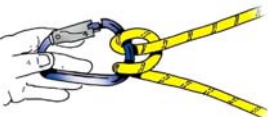
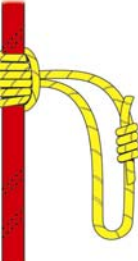
**Figure 6-19.** Munter/Mule Knot: Step 5



**Figure 6-20.** Munter/Mule Knot: Step 6



**Table 6-1.** Strength uses of Knots & Hitches

<b>Knot Type</b>	<b>Examples</b>	<b>Knot Strength</b> (% residual rope strength)	<b>Uses</b>
End Knot 	Tensionless Hitch Figure 9 Figure 8's Barrel Knot Double Figure 8 Bowline	100% 75% 70% 70% 65% 65%	Creates a loop in the end of the rope to connect to anchors, people, or equipment
Middle knot 	Butterfly	65%	Designed to be tied into the middle of a rope that will be subsequently tensioned
Bend (joining knot) 	Dbl. Fisherman's Water Knot	75% 65%	Designed to join two ropes
Stopper Knot 	Barrel Knot Figure 8 Figure 9	n/a	Tied into the end of a rope to prevent equipment from coming off the end.
Hitches 	Clove Munter (Italian) Munter Mule	Depends n/a	Used to connect rope to objects like posts
Friction Knot 	Prusik	Depends on diameter ratio, and type of rope/cord used	Uses friction to create a secure connection to a tensioned rope; similar to a rope grab





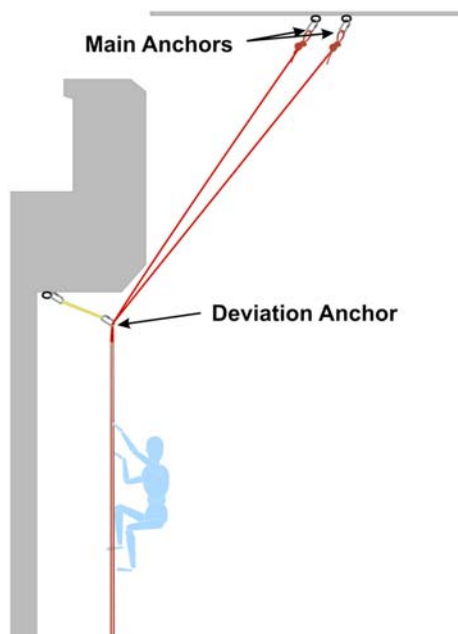
## Chapter 7. Anchors

The selection and installation of sound anchors is among the most important tasks required of a thoroughly trained and experienced rope-access technician.

### Terminology

An **anchor** is a general term for a fixed attachment point, or series of points, on a structure that supports the rope systems and other connections to personnel working at height.

**Main anchors** are those that directly support the life-safety system, while a **deviation anchor** is used to change the direction of the rope system.



**Figure 7-1.** Main and Deviation Anchors

One unquestionably strong **anchor point** can be used to create a **simple anchor**, or a series of anchor points can

be linked together to make a **multi-point anchor** system.

### Controlling Access to Anchors

Where access to the anchor points is not completely controlled, an attendant must stay at the anchor at all times to avoid tampering. Even where attendants are present, if the anchor is accessible to the public, the anchors and associated rigging must be frequently and carefully inspected. The attendant need not be a rope-access qualified person, but must be well versed in rope-access procedures. The attendant must also be equipped with a two-way radio to keep contact with rope-access personnel.

### Anchor Strength

Each anchor used in rope access must be designed to withstand at least twice the maximum anticipated dynamic load it is intended to support. The OSHA requirement for fall-arrest anchors is 5,000 pounds of force (lbf) (22.2 kN) per employee attached. In most cases, rope-access anchors must be built to meet this requirement.

It is usually unrealistic to proof-load or conduct an engineering analysis of every anchor point used in rope-access systems. Therefore, anchor fundamentals must be understood by personnel working in the field. A qualified person and/or professional engineer must be consulted if there is any doubt regarding the strength requirements or integrity of any anchor system.

The strength requirements of anchors can vary widely depending on how the anticipated forces may be applied. For example, the potential forces applied to an anchor during a fall onto a horizontal tensioned line would be much greater than those applied by a similar fall onto a vertical safety line.

**An anchor of questionable strength must never be used!** With few exceptions, alternative methods exist to improve the anchor or create a different one. If a suitable anchor is not located the work must not proceed! Rope access for industrial applications must be a pre-planned activity and there is no excuse for sub-optimal anchors.

### Independent Systems

Rope access protocols require that an independently-anchored safety system is used to back-up the main working rope when the rope is used as the primary means of support. Theoretically, this implies that anchor systems supporting each rope are always completely independent. In practice, however, these two anchor systems are often interconnected or may rely on the same anchor points.

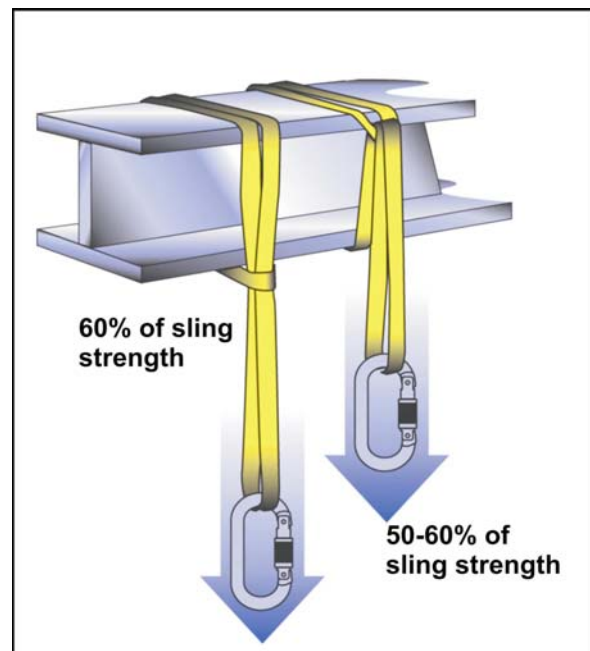
When creating anchors for a two-rope system, back-up every part of the system that can *potentially* fail. Anchor points, wire slings, synthetic straps, ropes, and connectors have the potential for failure in some circumstances. Once redundancy has been established, it is often preferable to connect the two systems together to provide back-up for each other.

### General Anchor Principles

- Anchorages must be placed outside of the Access Zone to allow workers to attach themselves to the fall protection system before entering the Access Zone.
- Use edge protection and other buffering material when needed to

protect slings from damage by sharp edges and contaminants.

- Pay attention to the proper loading of connectors – do not overload, load over edges or along more than one axis.
- Minimize leverage on anchor points by using the base of members such as rails and pipes.
- Use the strongest sling configuration possible (Fig. 7-2). The basket orientation is the strongest (theoretically twice the strength of the sling). The girth hitch may weaken the sling by 40%, while the friction and heat generated by a choked sling can weaken the anchor by over 50%!
- Anchors should be as simple as possible for ease of installation and inspection. The anchor should be installed in a timely fashion.

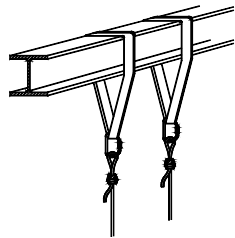


**Figure 7-2.** Basket, girth, and choked sling orientation for anchors.



### Simple Anchors

It is unnecessary and impractical to search for an entirely different anchor point to establish the anchor for the back-up rope system if the main anchor point will clearly not fail. There are many examples of simple anchors (Figure 7-3) in the industrial setting – steel girders, concrete pillars, etc. These are sometimes referred to as structural anchor points.



**Figure 7-3.** Simple anchors for a rope access system

### Multi-point Anchors

Linking multiple anchor points together to create an anchor system is common when using bolt anchors, railing posts, or equipment mounting brackets.

Multi-point anchors must offer *redundancy*. If one anchor point fails, the entire anchor must not fail. Furthermore, if one point fails, little to *no extension* should take place that might dynamically load the second point.

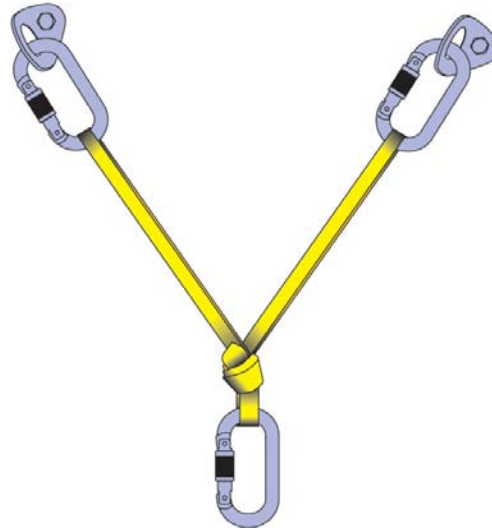
There are three types of multi-point anchors:

- 1) Backed-up
- 2) Load-sharing
- 3) Equalizing (load-distributing)

A *backed-up anchor* is an anchor that is connected to a secondary anchor point just in case the primary anchor point fails. The secondary anchor point does not share the load.

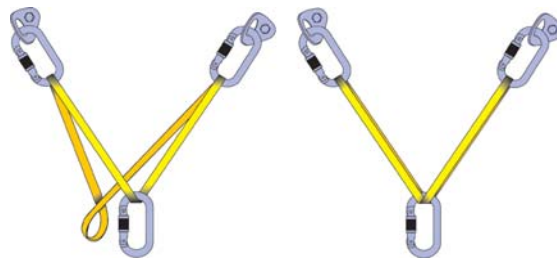
Each anchor point in a *load-sharing anchor* shares the load placed on it. A

load-sharing two-point anchor is often called a “Y” anchor (Figure 7-4)



**Figure 7-4.** Load-sharing sling anchor created by using an overhand knot.

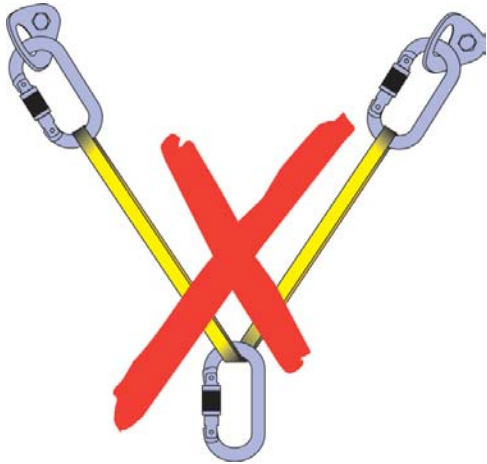
If the anchor is designed so that each leg shares the load equally even if the direction of the load shifts, it is called an *equalizing (or load-distributing) anchor*. Figure 7-5 shows the most common method of achieving an equalizing anchor. The main disadvantage of this type of anchor is if one anchor point fails, the extension will dynamically load the second anchor point. It is generally preferable to build a load-sharing anchor that will not extend in the event of a failure.



**Figure 7-5.** Equalizing (load-distributing) anchors



Figure 7-6 shows an equalizing anchor that does not offer redundancy. If one of the anchor points fails, the entire anchor fails!

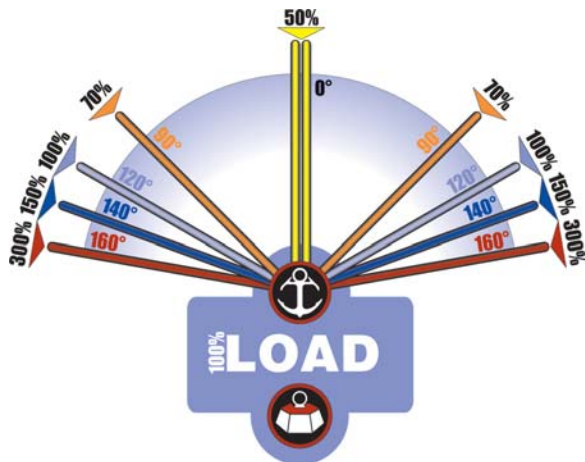


**Figure 7-6.** Danger! Equalizing anchor with no redundancy if one anchor fails.

**Angles**

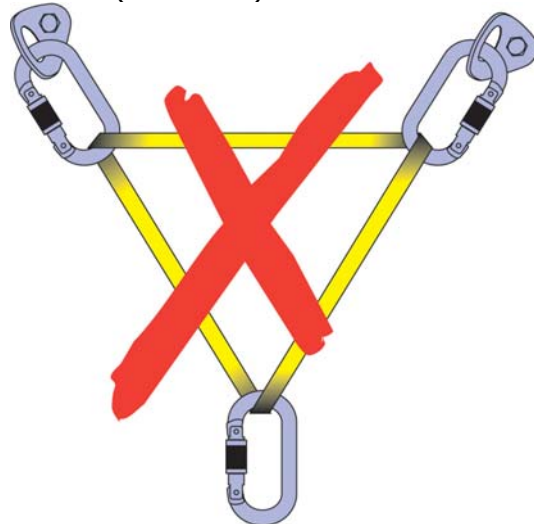
Angles created by connecting bridles or slings must always be considered when building multi-point anchors. As the angle created by the connecting bridle or sling increase, the greater the forces transferred to each anchor point (Fig. 7-7).

At 120 degrees the force placed on each leg of a two-point anchor is equal to the load placed on the entire system. The general rule is to keep the angle below 90 degrees.



**Figure 7-7.** Force on anchor points increase as the angles widen

The triangle configuration shown in Figure 7-8 must be avoided because the forces placed on each anchor point are greater than if a "Y-configuration" is used (Table 7-1).



**Figure 7-8.** The triangle configuration must be avoided due to excessive resultant forces on anchors.

$\alpha$ Angle	"Y"	"Triangle"
0	50%	70%
60	60%	100%
90	70%	130%
120	100%	190%
140	150%	290%
150	190%	380%
160	290%	570%
170	580%	1100%

**Table 7-1.** Forces on Anchor Points in Multi-point Anchors as angle and configuration of bridle changes.



The acronym EARNEST (Table 7-2) is useful for remembering the important aspects of building multiple-point anchors.

**Table 7-2.** Multi-point Anchor Characteristics

<b>Equalized or Load Sharing</b>	Connect anchor points in such a manner that each bears roughly an equal fraction of the force subjected to the anchor as a whole.
<b>Angles</b>	Pay attention to the angles created by the bridle connecting the anchor points—stay below 90 degrees.
<b>Redundant</b>	If one anchor point fails the anchor will not fail.
<b>No Extension</b>	To protect the system from dynamic loading, the anchor must not extend significantly if one anchor point fails.
<b>Solid</b>	Choose solid anchor points and visually inspect each one.
<b>Timely</b>	Each anchor must be constructed efficiently in terms of time and material and must be easy to inspect. The anchor is just one of many components in a safe system that requires attention.

**Installing Anchors**

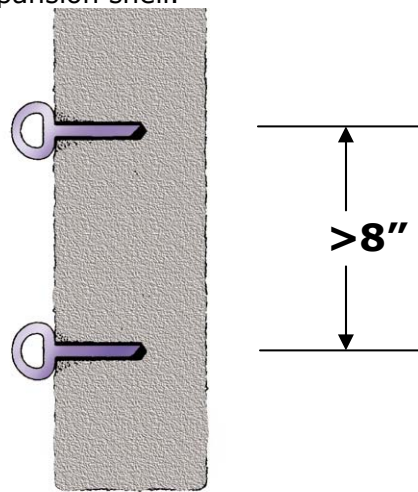
When no adequate anchors are readily available on the job site, anchor points must be installed. Installed anchors must be designed to meet the 5,000 lb. (22.2 kN) anchor strength standard.

Only qualified personnel shall direct and oversee the installation of anchors. Properly trained rope-access technicians can specify and install appropriate anchors designed for life-safety applications. A professional engineer must be consulted as appropriate.

At least two anchors are generally placed for rope-access systems. Three anchor points are preferred.

Anchors must be placed at least 8 inches (15 cm) apart and 8 inches (15 cm) from the edge of the substrate that is at least 8 inches (15 cm) thick (Figure 7-9).

Where possible, pull testing of the bolts is the best check of the installation. It is recommended that the bolts be pull tested to 1100 lbs. (5 kN) to assure proper seating of the expansion shell.



**Figure 7-9.** Anchor spacing

**Anchor Substrate**

Installed anchors are only as strong as the substrate material. Anchors shall only be placed in competent rock, concrete, or other suitable materials.

When placing bolts in rock or concrete, personnel must take care to assure that mass of the material in which the bolt is placed is competent. This can be done by sounding the material with a hammer. If the material sounds hollow, drummy, or the material is friable, the site must be rejected.

Personnel must examine rock carefully to look for fractures, bedding planes, or cleavage which might cause the rock to separate from surrounding



mass. A geologist and/or engineer should be consulted if questions remain regarding the integrity of the substrate or the anchor placed in it.

### Anchor Types

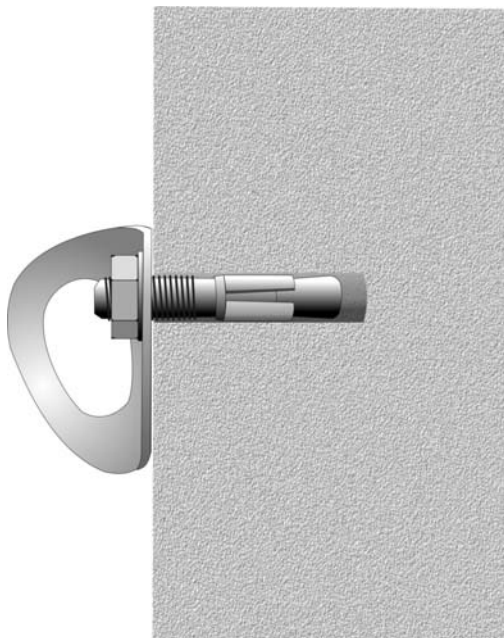
Two types of anchors are commonly installed:

- 1) Expansion bolts (Figure 7-10)
- 2) Epoxy resin anchors (Figure 7-12)

### Expansion Bolts

Expansion bolts take several forms. All expansion bolts employ an expandable shell that is actuated by screwing in, driving in, or tightening the body of the bolt. Expansion bolts used for anchors must be chosen carefully and clearly rated and appropriate for life-safety applications.

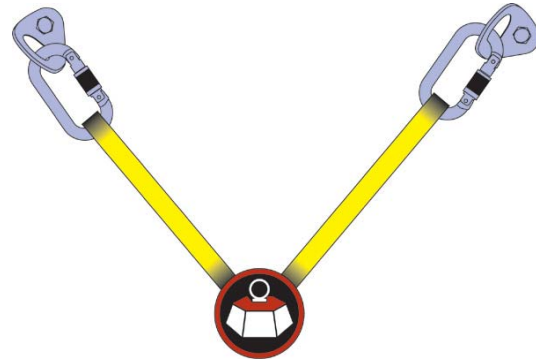
Expansion bolts are generally fitted with a metal hanger or plate used for attachment of connectors to the life-safety system. Most of these plates or hangers must be oriented properly to the direction of pull (Figure 7-11).



**Figure 7-10.** Expansion Bolt

Expansion bolts are generally designed to be loaded in shear, not in tension.

Although properly placed expansion bolts loaded in tension may be adequately strong for rope-access applications, the uncertainty inherent in the anchorage requires that bolts always be installed for and loaded in shear.



**Figure 7-11.** Hangers oriented for the direction of pull

Expansion bolts must be carefully torqued per manufacturer's directions. The recommended size of expansion bolts used in industrial rope access is ½ inch (12 mm).

### Epoxy Resin Anchors

Glue-in or resin anchors are generally more expensive than expansion bolts. They can be installed in less competent material, because they utilize the entire surface of the hole.

Resin can take the form of ampoules which are broken by screwing the bolt into the hole (usually through the ampoule), or two-part epoxies which are mixed in a specially designed gun, and forced down the hole by pressure on the trigger.

For mixed resins, fill the hole about half full (bottom out) with resin. When the bolt is inserted, the resin should extrude slightly from the collar of the hole. Proper curing time must be allowed before the bolt is used.

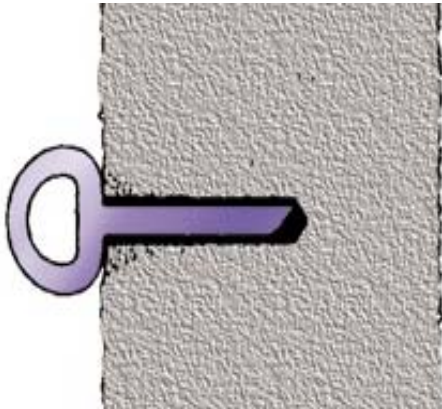
Only resins designed specifically for this type of application or recommended by the bolt





manufacturer shall be used. The installation must be in strict compliance with conditions and limitations stated by the manufacturer.

Adhesives can be sensitive to moisture, heat (especially during storage), cold (setting times), and disturbance once they have begun to harden.



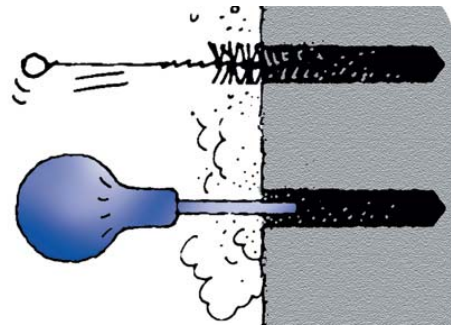
**Figure 7-12.** Epoxy resin anchor

### Installation of Anchors

Correct depth and size of hole are critical to a good installation. The hole must be thoroughly cleaned, as cuttings on the hole surface can prevent good glue adhesion of the glue. Cuttings can also keep the bolt from being installed to its designed depth. No anchor bolts shall be installed to a depth less than 4 inches.

Care must be exercised to assure that the bolt hole is drilled to a proper diameter, minimum depth, and the cuttings meticulously blown or sucked from the hole.

Small, round, wire brushes may also be used to rid the hole of cuttings (Figure 7-13). Cuttings can be blown out by the use of a rubber syringe, compressed air, or simply an adequate length of small diameter plastic vinyl hose.

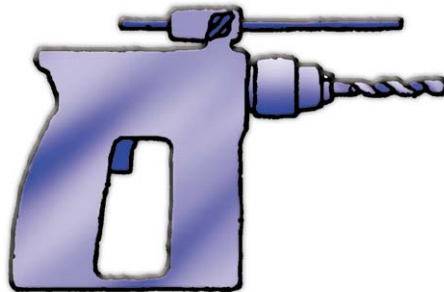


**Figure 7-13.** Wire brush and rubber syringe for cleaning holes.

### Bolt Kit

A standard anchor installation kit includes:

- 1) Cordless Hammer Drill (24 V DC) w/spare battery and charger (Figure 7-14)
- 2) Wire brush and rubber syringe
- 3) Drill bits
- 4) Torque wrench and sockets
- 5) Expansion bolts, hangers, and washers
- 6) Epoxy resin anchors with resin



**Figure 7-14.** Cordless Hammer Drill



**TIP!** Rechargeable batteries commonly discharge when not in use. Be sure to charge your drill batteries before you get to the work site, as anchor installation is usually one of the first tasks on a new job.



### Other Types of Anchors

At times, standard structural or installed anchors may not be feasible at some sites: vehicles, moveable equipment, or trees may be considered. Each Reclamation region may have its own regulations or policy regarding these types of anchors<sup>1</sup>. Personnel must always consult Regional or local policy, wherever applicable. If local policy is not present, the following are offered as recommendations:

When using vehicles as anchor points:

- The keys to the vehicle will remain in the custody of the suspended rope-access operative. A Tag-out label should be affixed to the steering column.
- Attach only to structural members on the vehicle. The attachment points must be able to meet the same 5000 lb. (22.2 kN) standard as any other anchorage.
- Install edge protection as necessary to protect rope or slings from sharp edges and/or grease on the vehicle.
- Park the vehicle well clear of the access zone. The vehicle must be on a clean, dry surface (gravel is not acceptable!). If possible, the vehicle should be behind a curb or parapet wall.
- **Park the vehicle so that the force is applied at right angles to the long axis of the vehicle.** Don't rely on the parking brake or the transmission to maintain your anchor!

Where moveable equipment (dozers, cranes, etc.) are used as anchors, strict

lockout/tagout procedures must be followed. Keeping the keys of the equipment with the suspended operatives also assures no one will drive away with the anchors! Apply the same rules listed above for anchoring to equipment.

### Trees

The use of trees as anchors is occasionally necessary at some sites. Considerable discussion has arisen about the suitability of trees for anchorage and what minimum standards are necessary.

Some suggest that a minimum diameter of 8" should be used. Factors affecting suitability include soundness of the tree (not dead!), root structure, and type of bark. The rope-access supervisor must ultimately decide if a specific tree provides adequate anchorage.

Precautions should also be taken to prevent damage to the tree from the rope moving around the trunk during operations.

---

<sup>1</sup> Some Reclamation regions or offices prohibit the use of moveable equipment or vehicles as anchors. Personnel must be familiar with local policy before using such equipment as part of a rope-access system.





## Chapter 8. System Analysis

While the majority of these *Guidelines* address the use of individual components or techniques for work-at-height, this chapter outlines criteria and tools to analyze the overall system. System analysis requires an understanding of the proper use of equipment and techniques along with some basic physics principles.

Some general system analysis concepts include:

- The system is only as strong as its weakest link
- A back-up system must be used when the main system is the primary means of access, support, or positioning.
- A falling mass (dynamic load) will generate a greater force than a stationary mass (static load)
- The distance of a potential fall as well as the impact force generated must be considered.
- The improper use of equipment can cause failure at substantially smaller loads than the device or system was designed for.
- Forces experienced by different parts of the system can change depending on how the system is configured.

### Back-up Safety Systems

The use of a back-up safety system is a central principle of rope-access methods. A back-up rope system must be employed when the working rope is the primary means of support. In rare circumstances, the elimination of the back-up rope system can be justified if it poses an additional hazard to the worker and no other viable method of access is available. If the worker's primary means of support is the ground or structure (e.g. work

platform), only one safety system is required.

Low-angle slopes may only require the use of a single work-positioning or fall-protection system. The angle at which a two-rope system is required depends on the coefficient of friction of the slope surface. Two-rope systems must be used on slopes over 40 degrees in nearly all cases, however, it may be prudent to use a two-rope system in considerably lower-angle environments. If the worker can maintain his or her position on the slope without the rope, a single-rope system may be employed. The use of a single-rope system is at the discretion of the site supervisor and must be documented in the work-methods statement and/or job-hazard analysis.

### Static and Dynamic Forces

Forces in work-at-height systems are applied statically and dynamically. A *static* load describes a load at rest (e.g. a worker in suspension). A *dynamic* load is introduced suddenly, as in the case of a fall.

The *Peak Impact Force* is a measurement of the maximum force experienced by the body during a fall. Per OSHA and CSA requirements, all fall-protection systems, including rope-access systems, must be designed to limit the peak impact force experienced by a falling worker to 1794 lbF (8 kN).

Force is equal to mass times acceleration. The mass of an object at rest is measured in kilograms (kg) or pounds (lbs). Forces are reported in Newtons (N). A Newton (N) is the force that must be exerted on a

1 kg mass to make it accelerate at 1 meter per second per second (1 m/s<sup>2</sup>).

The acceleration of mass subjected to Earth’s gravity is 32 ft/sec<sup>2</sup> (9.81 m/s<sup>2</sup>). The resultant force of a 1 kg mass that is acted on by gravity is 9.81 N. 1 kN can be converted to kilograms and pounds using the formula below:

Force= Mass x Acceleration  
 Force = 1 kg x 9.81 m/s<sup>2</sup>  
 Force = 9.81 N  
 Since 9.81 N is equivalent to 1 kg acted on by gravity then  
 1 kN (1000 N) is equivalent to 101.94 kg (224.3 lbs)

**Table 8-1.** Metric/SAE Conversion

Metric	U.S.
1 kg (100 grams)	2.2 lbs
1 kN (1000 N)	224.27 lbF
1 meter	3.28 feet

In the course of normal rope-access work, both dynamic and static forces are applied to the system. Typical forces generated by rope-access activities are shown in Table 8-2.

**Table 8-2.** Forces generated by 220 lb (100 kg) worker.

Activity	Peak Force
Rest (220 lb)	220 lbF (.98kN)
Ascending	314 lbF (1.4 kN)
Descending	269 lbF (1.2 kN)
Working	269 lbF (1.2 kN)
Ascending/Descending Rapidly	493 lbF (2.2 kN)
Fall onto Shunt™ (approx. 6 ft or 2 mm)	675-900 lbF (3-4 kN)

**Impact Force vs. Fall Distance**

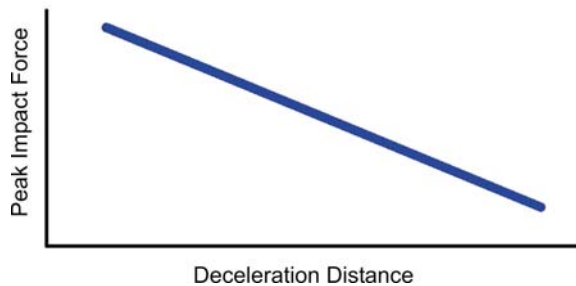
Rope-access systems are designed to prevent a fall from occurring in the first place. If there is a failure in the main support system and a fall occurs, the

back-up safety system must limit the impact force felt while limiting the total fall distance traveled during the fall. The total fall distance is usually the free fall distance plus the deceleration distance.

The free fall distance is the distance fallen before the deceleration device (e.g. shock absorber or rope grab) engages and begins to arrest the fall. The deceleration distance is the additional distance traveled by a falling worker between the moment the deceleration device engages and the fall is arrested.

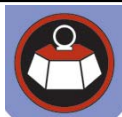
Total Fall Distance = Free Fall Distance + Deceleration Distance

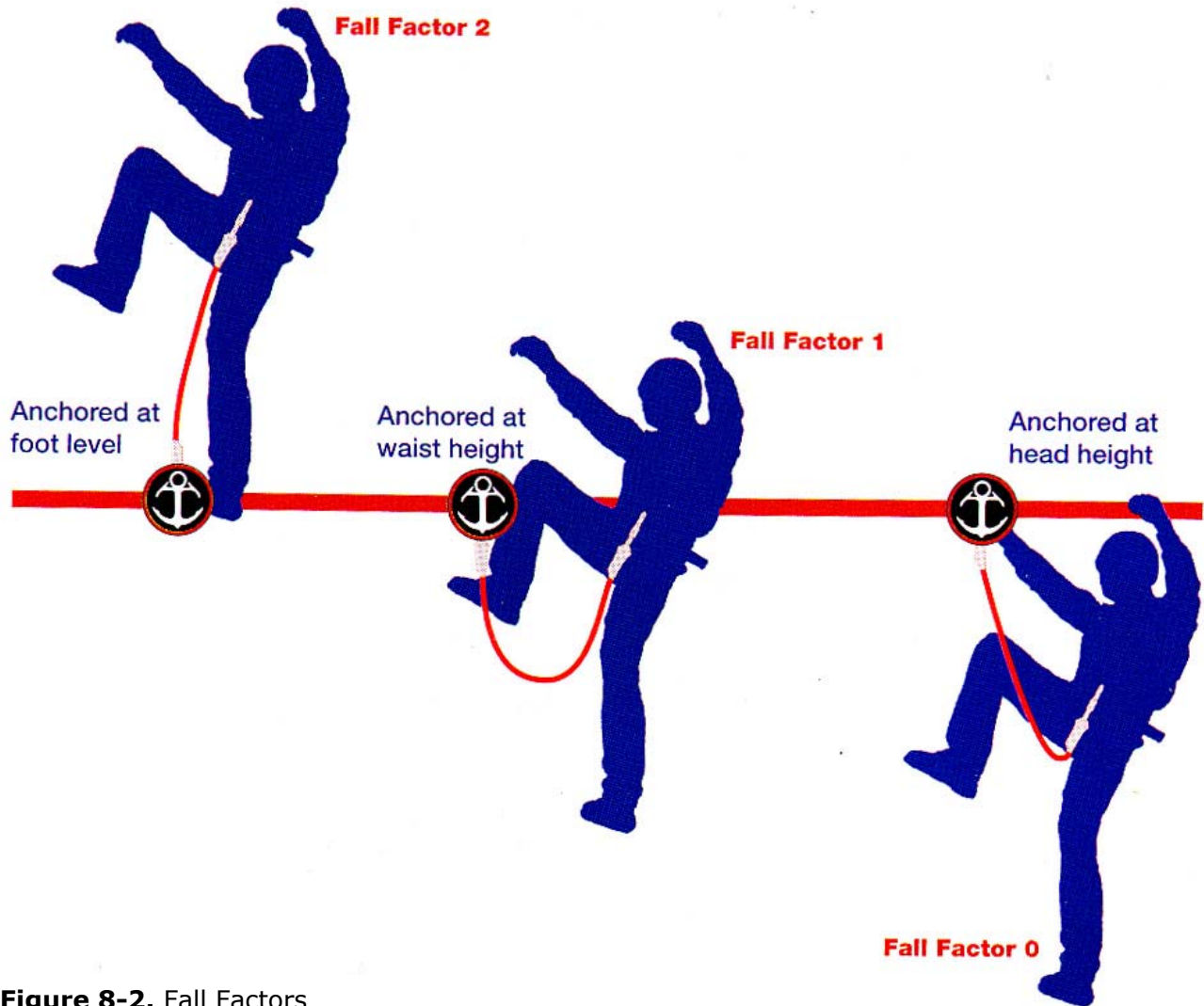
An inverse relationship exists between the deceleration distance and impact force (Figure 8-1). Generally, the shorter the deceleration distance, the higher the impact force.



**Figure 8-1.** Relationship between impact force and deceleration distance during fall arrest

**Example:** In a typical rope-access system the back-up device (e.g. Petzl Shunt) is used as a deceleration device. The device slips on the rope when impacted and dissipates some of the forces generated. Based on empirical testing, the impact force generated by a fall of 6 feet onto a Petzl Shunt (11mm rope) is 3-4 kN while the deceleration distance is between 80-160 cm.





**Figure 8-2.** Fall Factors

**Fall Factor**

The *fall factor* can be a useful way to describe the proportional seriousness of a fall. The fall factor is defined as the maximum distance a worker can fall divided by the length of rope (or lanyard connection) between the falling worker and the anchor.

Fall Factor = Free Fall Distance/Length of Rope (lanyard)

**Example:** A 3-foot fall on a 3-foot rope lanyard would result in a fall factor of 0.5. The maximum fall factor in most situations is 2.

It is possible to create a dangerous situation where the fall factor exceeds 2. In Figure 8-3, the worker has attached a lanyard to a vertical lifeline without a cable or rope grab. The resulting fall may be 9 feet on a 3 foot lanyard, for example. A fall factor of 3 will result in a very high and potentially lethal impact force!

**Important note:** The fall factor only describes the distance of the fall in relation to the length of the connection to the anchor. It does not give you the more important measurement of peak impact force.





**Figure 8-3.**  
Large Fall  
Factor  
Example

MBS is always a lower and more conservative number. If the force required to break the equipment is relatively consistent, the difference between the MBS and ABS is small. If the breaking force required is not consistent, the MBS will be substantially lower than the ABS.

*Working Load Limit (WLL)* is intended to notify the user the maximum load a piece of equipment is designed to lift, support, or move. The WLL is usually determined by the manufacturer by dividing the ABS or MBS by a *safety factor*. For example, if the accepted safety factor is 5, and the ABS is 10,000 lbs., a manufacturer may determine the WLL as 2,000 lbs.

*Safe Working Load (SWL)* identifies the maximum load a piece of equipment can carry under specific service conditions. The specific service condition might be a life-safety application. In this case, the SWL is usually determined by a qualified person.

Unfortunately, there is no one standard strength design system yet established for rope access or associated equipment. Equipment may come marked with MBS (typically carabiners are marked this way), while other components of the system such as slings may come marked with SWL. It is incumbent on the rope access supervisor to understand the differing terminology when designing the access system on any job.

Additionally, the Cordage Institute® has established 14 critical conditions of use that must be considered when determining the WLL for ropes. These conditions are listed in Table 8-4 at the end of this chapter. These factors should be considered whenever deciding the safety factors necessary in a system design.

### **Equipment: Determining Strength**

The strength of equipment used in rope-access and other life-safety systems may be reported in any of the following ways:

- 1) Average Breaking Strength (ABS)
- 2) Minimum Breaking Strength (MBS)
- 3) Working Load Limit (WLL)
- 4) Safe Working Load (SWL)<sup>1</sup>

*Average Breaking Strength (ABS)* is simply the average force that it takes to break a piece of equipment.

*Minimum Breaking Strength (MBS)* is usually derived by subtracting three standard deviations (using the appropriate statistical formula) from the ABS. The

<sup>1</sup> IRATA provides further discussion of these terms at [http://www.irata.org/uploads/healthandsafety/WLLS\\_WL.pdf](http://www.irata.org/uploads/healthandsafety/WLLS_WL.pdf)



**Equipment: Proper Use**

The improper use of equipment can cause failure at substantially smaller loads than otherwise expected. A detailed discussion of proper equipment use is beyond the scope of this chapter. Typical components used in a rope-access system are discussed in more detail in Chapter 5. Manufacturer instructions must always be consulted.

Some typical examples of improper use of equipment are mentioned here. This is not an exhaustive list.

- Carabiners overloaded or loaded along minor axis or over a hard edge (Chapter 5)
- Webbing slings used in a tensioning girth hitch (Chapter 5)
- Ascenders loaded horizontally or in a bottom of a loop (Chapter 5)
- Rope loaded over a sharp edge.
- Expansion bolts loaded in tension (outward pull), rather than in shear (perpendicular to the bolt). (Chapter 7)

**Angles and Resultant Forces**

Forces experienced by different parts of the system can change dramatically depending on how the system is configured.

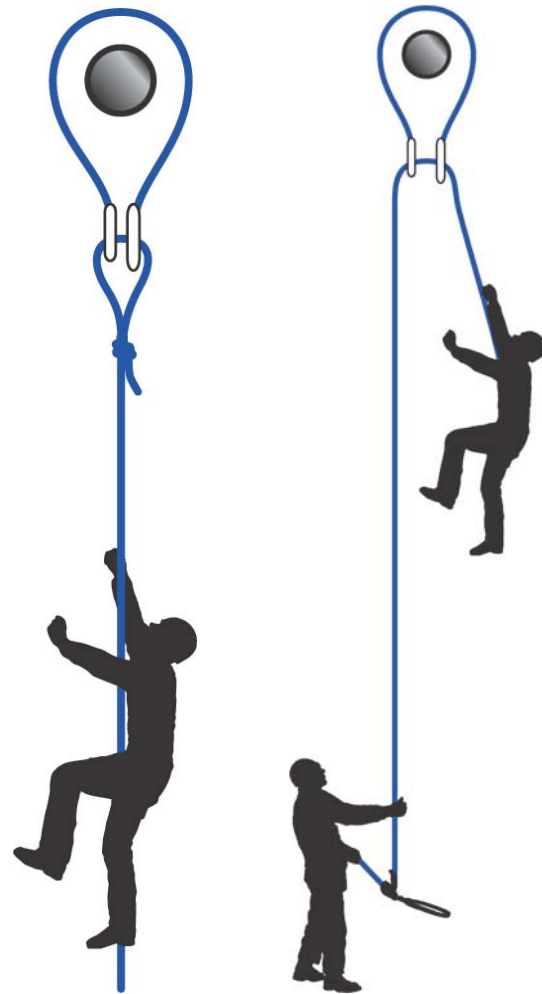
In a simple overhead fixed-rope situation, the force experienced by the worker is the equal to the force applied to the anchors. If the rope runs freely through a high-anchor point before reaching the worker (e.g. sling-shot belay), the force at the anchor is twice that experienced by the worker in a fall. (See Figure 8-4)

The internal angle of a rigging bridle in an anchor (Chapter 7), or the deflection angle of a highline (Chapter 10) dramatically affects the resultant forces on the anchor points. The greater the angle, the higher the forces on each anchor point.

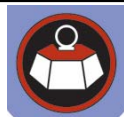
In an anchor, the internal angle created by the bridle (rigging strap or rope) of an

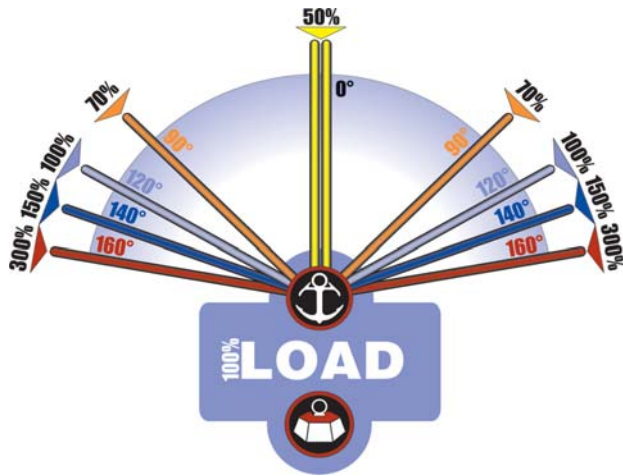
anchor must not exceed 90 degrees. A longer bridle must be used if the angle is too large.

In a high line, the angle of deflection and load placed on the system must be carefully monitored to insure that the rope and anchors are not overloaded. Dynamic forces generated in an unexpected failure of a portion of the system must also be considered. For further high-line discussions see Chapter 10.



**Figure 8-4.** Fixed Rope and Sling-shot belay.

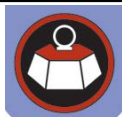




**Figure 8-5.** Angles and Resultant Forces in Anchors and High lines

**Table 8-3.** Critical Conditions of Rope Use

Number	Critical Factor
1	Small ropes are used because they can be more severely damaged by cutting, abrasion and sunlight
2	Loads are not accurately known
3	Operators are poorly trained
4	Operation /use procedures are not well defined and/or controlled
5	Inspection is infrequent
6	Abrasion, cutting, dirt are present
7	Shock loads or extreme dynamic loadings are likely
8	High temperatures are present
9	Chemicals are present
10	Ropes are kept in service indefinitely
11	Tensions on the rope are maintained continuously for long periods
12	Rope can be subject to sharp bends or is used over pulleys or surfaces with too small a radius
13	If knots are used, strength is reduced by up to 50%
14	Death, injury or loss of valuable property may result from failure







## Chapter 9. Rope-Access Technique

This chapter outlines techniques used by rope-access personnel for access, support, and fall protection. The first part of the chapter discusses various methods for managing the safety system, while the second part addresses specific rope-access techniques.

The following discussion of techniques is not exhaustive and must not be considered a replacement for proper training. The techniques herein require more training than traditional access and fall-protection methods. The use of these techniques must be supervised appropriately.

### The Safety System

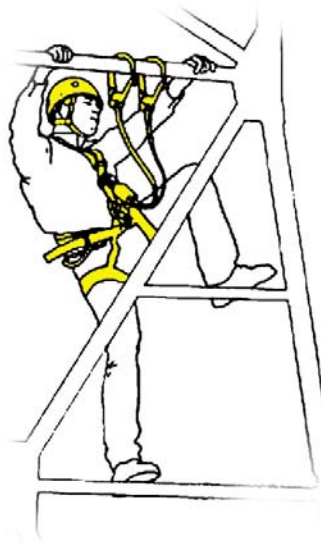
Typical rope-access systems provide an efficient means of *access*, *support*, and *fall protection* through the use of a two-rope system, where the *working rope* is used for access and support while the *safety rope* is used as back-up in the event of a failure in the main working system.

A back-up rope system must always be employed when the working rope is the primary means of support. In rare circumstances, the elimination of the back-up rope system can be justified if it poses an additional hazard to the worker and no other viable method of access is available.

If the worker's primary means of support is the ground or structure (e.g. work platform or tower structure), only one safety system or rope is required. Techniques used when the structure is the primary means of support are included.

Properly trained rope-access technicians may employ any of the following methods for their safety system:

- 1) Direct lanyard connection to the structure or anchor
- 2) vertical safety line using an attended belay or self-belay
- 3) triangulated vertical safety lines
- 4) horizontal safety line
- 5) attended belay for lead climbing



**Figure 9-1.** Direct Lanyard Connection to Structure

### Direct Lanyard Connection

Perhaps the most basic form of fall protection available to personnel working at height involves a lanyard connection from the worker's harness directly to an anchor on the structure itself. The system can be cumbersome while climbing because at least one hand must be used to move the connection when the worker progresses. Two lanyards or a Y-lanyard is used to insure constant connection to the structure.

Although simple in principle, this form of fall protection can expose a worker to significant hazards during a fall. Care must be taken to limit the distance of the fall, control impact forces, and insure that adequate clearance is available to prevent injury from striking obstacles below.

Lanyards must always be connected as high as possible! If a fall of more than two feet (60 cm) can be expected, an energy-absorbing lanyard must be used to minimize the impact force felt by the falling worker.

Dynamic rope lanyards used in rope access (attached to central waist D-ring) can be used for direct connection to structures provided the potential fall is limited to 2 feet or less.

The leg of Y-lanyard that is not in use must be left hanging or clipped to the anchor (directly or indirectly), but must not be clipped back to the harness where it would interfere with deployment of the energy absorber (Figure 9-2).

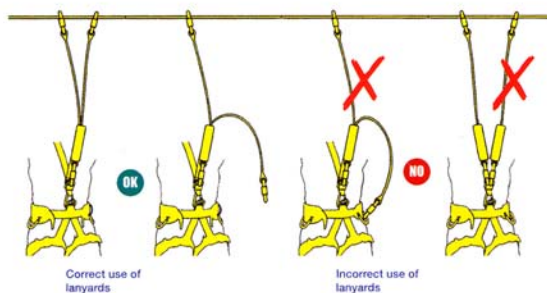
### Vertical Safety Line: Attended Belay

An attended belay is an active system operated by an individual, stationed at a fixed anchor, designed to arrest the fall of a worker who is attached to the end of the rope. The person operating the belay system is called the belayer.

An attended belay is used when the worker needs his or her hands free for climbing the structure or to manage a work task. An example of an attended belay is shown in a lead climbing situation in Figure 9-8.

Belayers must be attached directly to a suitable anchor point especially when a risk of falling exists. This connection must be short enough to prevent him/her from being pulled off the edge of a structure.

Whenever possible, the belay device should be attached directly to the anchor as in Figure 9-3.



**Figure 9-2.** Proper use of Y-lanyard





**Figure 9-3:** Belay device connected to anchor.

The belayer must always maintain a hand on the control rope (the slack end of the rope) and maintain a proper amount of rope between the belay device and the worker (little to no slack, without tension).

Self-locking devices such as the Petzl Grigri or I'D should be used whenever practical. These devices have an active cam that locks onto the rope when loaded suddenly. Many "self-locking" belay devices require the user to lock them off manually when left unattended.

**Vertical Safety Line: Self-Belay**

In rope access, the technique of managing your own back-up safety rope is often called **self-belay**. Devices used for self-belay in rope access are generally referred to as **back-up devices**.

Workers use an appropriate rope grab (or mobile fall-arrestor) that travels along the safety line as they ascend or descend. The rope grab may be connected directly to the

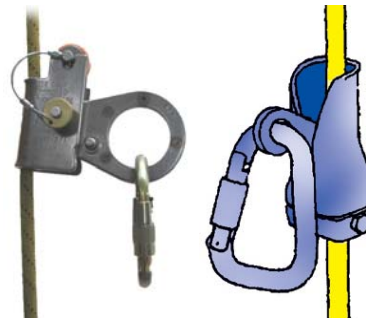
worker's harness, or indirectly with a lanyard. Although, a direct connection from the harness to the rope grab will yield the lowest fall potential and impact force, a lanyard connection is appropriate for most rope-access applications.

Most back-up devices do not require the use of a shock-absorbing lanyard because the devices usually slip on the rope to absorb some of the impact of a fall.

The performance of back-up devices varies significantly depending on the manner of use. Lanyard type and length as well as compatibility of the device with the rope (type, diameter and manufacturer) is very important. The back-up system must meet the demands of a potential fall.

Two common types of back-up devices are used:

1. "Self-trailing" ANSI-labeled devices (e.g. MIO Rope Grab) designed to follow the user automatically
2. "Towed" devices (e.g. Petzl Shunt) that must be adjusted manually by the user



**Figure 9-4.** Back-up Devices; Left, MIO Rope Grab (ANSI "self-trailing") and right, Petzl Shunt ("towed").

An ANSI-labeled (Z359.1) "fall-arrest rope grab" must meet specific



strength requirements, be self-trailing, and be difficult to defeat by the user. Most of these devices do not "self-trail" while descending.

An ANSI-labeled fall-arrest rope grab is not required for rope-access systems; however specific training in the proper use of either a "self-trailing" or "towed" back-up device is necessary.

A "towed" device, such as the Petzl Shunt, is the most commonly used back-up device used in rope-access systems. This type of device has several advantages for rope-access applications; however the following protocol must be followed to insure safe operation of any back-up device, especially the Petzl Shunt.

- Always keep the device as high as possible to minimize the distance of a potential fall.
- The length of the connection to the back-up device should be limited to 3 feet (1 m) including connections.
- Do not manually manipulate the device by grabbing the body.
- Move the device up by handling the lanyard or carabiner.
- If the device does not move down by itself, a tow-string should be used that does not interfere with the operation of the device. The tow-string must not have a loop, large knot, or be wrapped around the operators finger that might defeat the device in the event of a fall.

- Shock-absorbing lanyards are not needed when connecting to most back-up devices or mobile fall arrestors because the device slips to absorb energy in the fall.
- Toothed or handled ascenders are not appropriate for use as a back-up device because most will damage the rope if subjected to a dynamic load.

### **Triangulated Vertical Safety Lines**

Ideally, a vertical safety line should be anchored directly overhead. To protect the worker from injury from a pendulum fall, the worker must never be positioned more than 40 degrees to either side of vertical. Sharp or hazardous objects to either side of the vertical position may require a stricter protocol.

If the vertical safety line cannot be positioned directly above the worker, or the work requires horizontal traversing, two safety systems anchored above each end of the work area can be used.

If the triangulated safety system is the workers primary support, a total of four independent ropes are required. (See rope-to-rope transfer).

The angle created by the two safety systems should be kept below 90 degrees to minimize the forces on the anchors in the event of a fall. Additional safety systems can be employed to allow the worker to move in a three-dimensional space; however the additional complication can often limit the efficiency of the system.





**Figure 9-5.** Petzl Shunt used as a back-up device placed on safety rope.



**Figure 9-7.** Move back-up device up using the carabiner.



**Figure 9-6.** Moving back-up device down using tow string.



**Figure 9-8.** Do not handle body of back-up device.

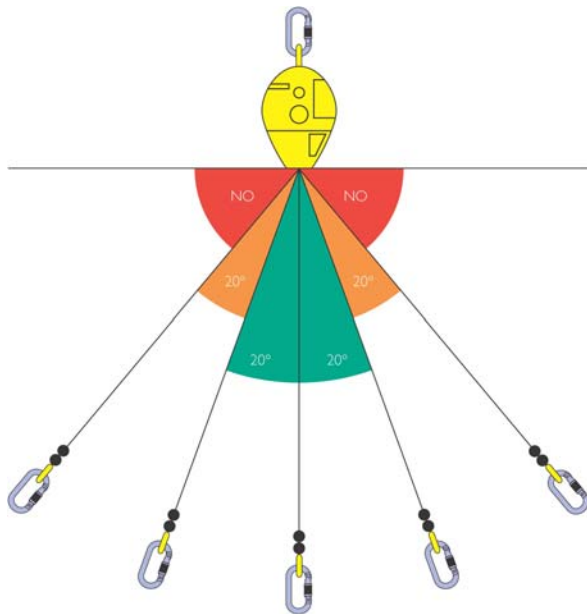


**Temporary Horizontal Safety Line**

A temporary horizontal safety line can be installed to provide fall protection for personnel working near an exposed edge for a short duration. Permanent fall-protection solutions should be installed for worksites requiring routine access.

The worker must remain connected to the horizontal lifeline by means of a lanyard attached to the harness. A Y-lanyard or two-separate lanyards are required to maintain a constant connection while passing obstacles. The type of lanyard used depends on the anticipated fall factor and resulting impact forces expected in a fall.

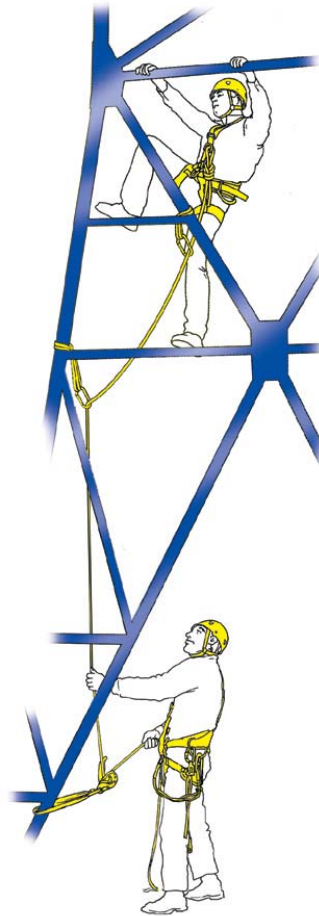
Significant forces, on the anchor and ropes, may be generated during a fall onto a horizontal safety line. These systems should be designed and installed by qualified personnel. A detailed discussion of the installation of horizontal safety systems is beyond the scope of this document.



**Figure 9-9.** 40 degree cone of safety with overhead lifelines.

**Lead Climbing**

Lead climbing can be used to protect the first worker while climbing or traversing a structure. Lead climbing is often used vertically by the first climber on a tower (Figure 9-10) or horizontally by a worker traversing a structure, such as a bridge.



**Figure 9-10.** Vertical lead climbing

Lead-climbing operations should be performed by properly trained and experienced rope-access technicians only. Because lead-climbing techniques can expose the technician to a larger fall potential than alternate techniques, lead climbing should be undertaken only after



other fall-protection methods are considered.

A dynamic kernmantle rope should be used. The climber connects the safety line to the sternal attachment point. An appropriate end knot, such as a figure eight, should be tied directly into the sternal D-ring, or indirectly through a locking connector.

The amount of slack between the climber and the anchor is managed by another employee (belayer) with the use of a belay device. The belayer must have specific training for belaying a lead climber. The belay device must be connected directly to the anchor point and not directly to the belayer.

As the climber advances, the rope is clipped into intermediate anchor points using a locking carabiner or other connector. To minimize the potential free-fall distance to six (6) feet, the optimal placement of intermediate anchor points is every three (3) feet. Structural members and other obstacles below the climber must be considered.

Extreme care should be taken to direct ropes around hazardous edges using anchoring and buffering techniques.

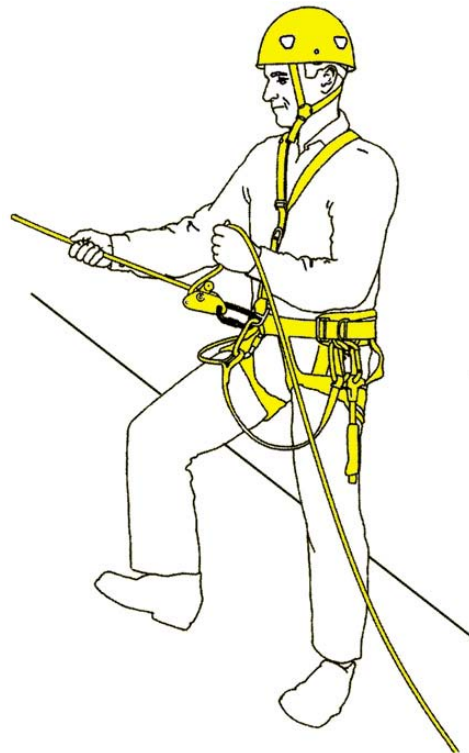
Two ropes are not required for lead-climbing operations, however the use of two ropes can be useful if the climber is establishing a rope-access system for descent or subsequent workers. In some horizontal applications, the second rope can be used to retrieve a fallen climber remotely. If a second rope is "trailed", the climber must take care to manage the route of the rope to avoid entanglement or produce unwanted friction in the system.

### **Fall Restraint on Low-angle Slopes**

Low-angle slopes may only require the use of a single rope system. The angle at which a two-rope system is required depends on the coefficient of friction of the slope surface. A single-rope system may be used on slopes under 40 degrees if two conditions exist:

1. the worker can maintain his or her position on the slope without the support of the rope,
2. and the worker does not routinely load the system by leaning back onto the rope.

The use of a single-rope system is at the discretion of the site supervisor and should be documented in the work plan and/or job hazard analysis.



**Figure 9-11.** Single-rope system used in low-angle environments.



**Rope-access Descent**

Descent using rope-access techniques is generally accomplished by one of two methods:

- 1) rappelling (traveling brake) or
- 2) lowering (fixed brake)

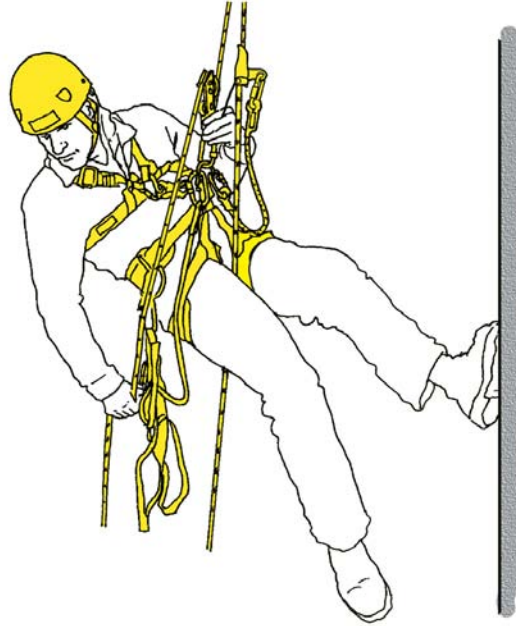
A method of reversing the descent operation (ascending or raising) should be available in case of unexpected complications.

**Descenders:** Most descent-control devices (descenders) can be used for lowering or rappelling. Descenders employ the concept of friction to control the rate of descent. Descenders used in industrial work applications should be outfitted with a self-braking mechanism that engages if the operator lets go of the system.

Some devices (e.g. Petzl Stop or I'D) have an integrated self-braking mechanism, while others (rappel rack or figure 8) should be used in conjunction with a mechanical or rope prusik to create a self-braking mechanism. See Chapter 5 for more information on descenders.

It is possible for a descender to release the load unexpectedly when a self-braking device is activated without the control rope firmly held by the operator. **Don't let go of the control rope!**

**Rappelling:** Rappelling (a.k.a. abseiling) with a traveling descent control device (descender) is the most common and versatile method of descending because it gives the operator control of his or her own rate of descent and does not require constant monitoring by other personnel.



**Figure 9-12.** Rope-access descent by rappelling (abseiling)

A fixed "low-stretch" rope and a back-up safety system attached to two independent anchors is used while rappelling. If ropes do not reach the ground a stopper knot (e.g. barrel knot) should be tied in the end of the rope to prevent the worker from descending off the end.

**Lowering:** An operative can be lowered by the use of a fixed brake attached to an anchor. The anchored descent control device is operated by a second person, thereby allowing the worker to be placed into position without the need for him or her to manage their own descender. A third person may be needed to operate the back-up safety system using an attended belay.





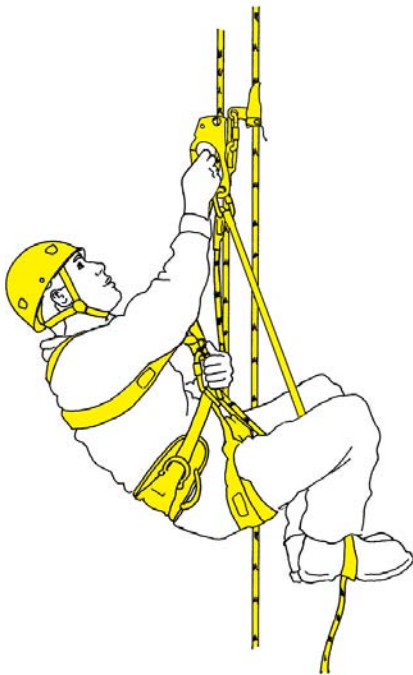
**Rope-access Ascent**

Rope-access personnel can move up vertically by:

- 1) climbing the rope using mechanical rope grabs (ascenders) or
- 2) being raised by co-workers using a mechanical advantage system.

In either method, a back-up safety system must be employed.

Climbing the rope involves the use of mechanical rope grabs (ascenders) move up a rope attached to a suitable anchor.



**Figure 9-13.** Climbing the rope using mechanical ascenders.

Numerous ascending systems are possible. Most require the use of two rope grabs (ascenders), both of which must be attached directly to the harness. Upward progress is made by moving the devices up in an alternating fashion.

The most commonly used system, called the "frog system", employs a

chest-mounted ascender attached directly to the harness and a handled ascender connected by a lanyard, or "cow's tail" (Figure 9-13). Both ascending devices must be attached securely to the harness!

It is also possible to use a descender to ascend the rope (see Figure 9-14) This method, known as the R.A.D. system (Rope Ascending and Descending System), is useful when the operative needs to move up and down the rope for short distances frequently. It is not an efficient method for long ascents. This system can also be modified to create a quick hauling system during rescues (see Chapter 11, Rescue Protocol).



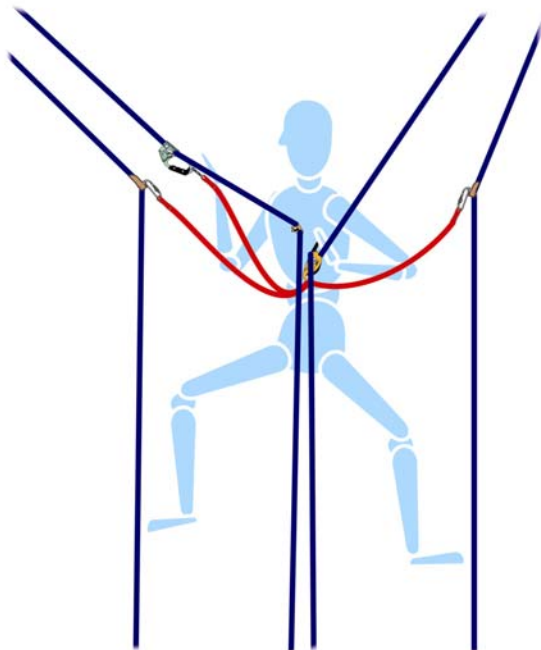
**Figure 9-14.** Rope ascending and descending system (R.A.D.)



**Rope-to-Rope Transfer (Triangulation).**

A rope-to-rope transfer is commonly used to move horizontally or to switch rope systems. Two pairs of ropes attached to two pairs of anchors are used (Figure 9-15, 16). Workers ascend or descend each pair of ropes to position themselves as needed in a two-dimensional plane. A second back-up device and/or descender is often used. The angle between the two sets of ropes should be kept below 90 degrees to minimize the forces transferred to the anchors.

The use of four separate ropes is standard procedure, however the site-safety supervisor may specify fewer ropes if the pendulum potential is insignificant, or additional ropes create a greater hazard.



**Figure 9-15.** Rope to Rope Transfer



**Figure 9-16.** Rope to rope transfer

**Changing the path of the rope**

Rope access systems must be positioned directly over the work area and the path of the rope should avoid hazards such as sharp edges, heat sources, machinery, and chemicals. A *deviation* or *intermediate anchor* can be installed if the natural hang of the rope from the main anchor does not direct it properly. Intermediate anchors and deviations are also placed to improve access and insure the performance of the safety system when long vertical drops or wind is considered.

**Deviations**

A *deviation* is created by clipping the rope(s) into a carabiner and sling attached to an anchor point that establishes the desired rope path. The anchor point used to redirect the rope should be sufficiently strong enough to handle the load placed on it, but may not necessarily need to meet the same criteria as a main anchor system.

The deviation should not redirect the rope more than 30 degrees. Establishing an intermediate anchor

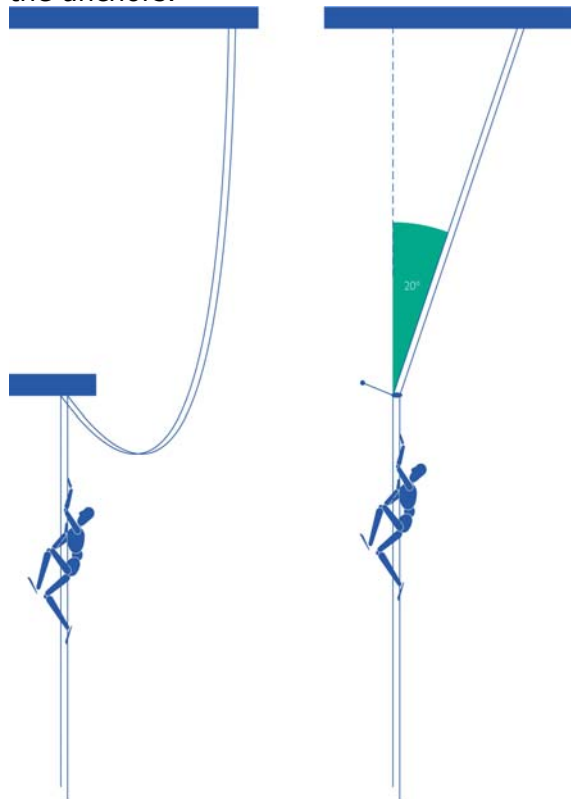


station (described in next section) may be more appropriate if a larger deviation is required.

To pass a deviation, the operative's equipment should not be removed from the rope! A knot can be tied in the rope below the deviation if the operator must return to the deviation from above.

**Intermediate Anchors (Rebelay)**

An intermediate anchor is often used to avoid edge hazards, change the position of the rope, or shorten the distance between the operative and the anchors.



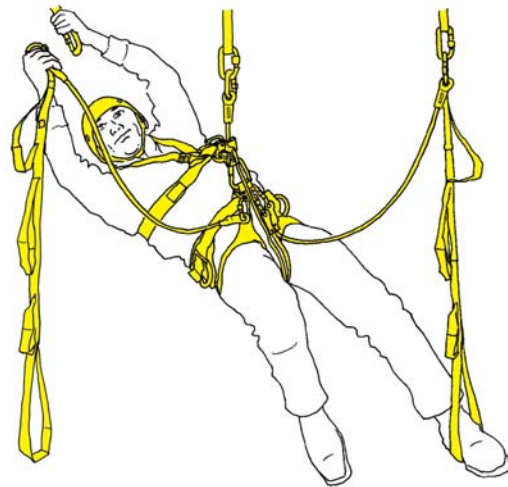
**Figure 9-17.** Two methods to handle a change of direction in rope path: An intermediate anchor or rebelay (left) and a deviation (right)

Intermediate anchors are especially useful when wind becomes a safety factor. Because the safety rope has some elastic qualities, the rope should be tied to an anchor at

regular intervals to minimize the distance of a potential fall if the operative was to suddenly load the safety system.

**Aid Climbing**

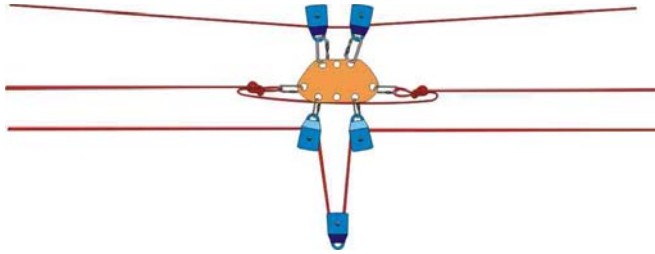
Properly trained rope-access workers can traverse underneath a structure or horizontally along a series of fixed anchor points by using aid climbing methods.



**Figure 9-18.** Horizontal aid climbing

Two independent points of attachment must be maintained at all times. Three separate lanyards are needed (two attached and one moving). Two of the lanyards should be long enough to allow full extension of the arms, while one short lanyard is used for suspension of the operative. The short lanyard can be a fixed length or adjusted by using a chest ascender. The chest ascender or sternal D-ring of the harness is used to help support the worker while aid climbing. Horizontal movement can be achieved by moving the lanyards from anchor point to anchor point, or shuffling the anchor straps along a structural member.





## Chapter 10. Tool and Load Management

The management of tools, chemicals, instruments and other materials must be an integral part of the work planning stage of all rope-access jobs. This planning must take place well in advance of the scheduled work in order to allow for the design and/or purchase of systems to safely and efficiently manage the tools and materials. Special consideration must be given not only to how to get the tools and materials in place, but what hazards may be introduced to the workers, bystanders and the public.

### General Tool and Load Management

The following guidelines must be considered and implemented while working with tools and loads:

1. Ensure the use of tools and the management of the loads are compatible with rope-access systems.
2. Consider the hazards introduced to workers, other personnel, the public, and surrounding structures. Use proper methods to mitigate these hazards.
3. Follow applicable standards for managing electrical tools and hazardous materials.
4. Small bolts, nuts, and other materials should be contained in a suitable bag with a secure zip or drawstring closure.
5. All other tools and materials must be tethered regardless of weight.
6. All items heavier than 22 lbs (10 kg) must be supported by an additional work line<sup>1</sup>.

<sup>1</sup> Current SPRAT and IRATA requirements are 10 lbs and 8 kg respectively based on the use of sit harnesses. 10 kg is used here because full-body harnesses can accommodate more weight safely.

7. All loads greater than 110 lbs (50 kg) must be attached to anchors independent of the rope-access system.
8. Lifting and lowering of loads greater than 550 lbs (250 kg) must be done using specialized equipment designed for this type of operation. **Section 19 – Hoisting Equipment, Piledrivers, and Conveyors** of the Reclamation Safety and Health Standards, and **Section 18 – Slings, Chains, and Accessories** detail USBR requirements for such activities.
9. Other site limitations must be considered including the presence of overhead wires, energized circuits, and other work crews.
10. Complete containment of the work area through the use of netting, plastic, or other temporary shields must be considered when working over public thoroughfares and/or utilizing paint, toxic substances, or other hazardous materials.

### Small Loads and Tools

All tools, regardless of weight, must be tethered or otherwise secured. Multi-purpose harnesses used in rope-access usually have gear loops designed for connecting tools and equipment. The maximum weight of a tool attached to a harness must not exceed 22 lbs (10 kg) for the following reasons:

- a. Most gear loops are not designed to support substantial weight.
- b. The overall rope-access system is designed around an assumed 220 lb (100 kg) operative, and additional weight may affect the integrity of the system.

- c. The fit and safety of the harness may be affected.
- d. The mobility of the worker may be impaired.

Important! Any load of more than 22 lbs (10 kg) must be supported by a separate rope!

Small items such as bolts, nuts, washers, fittings, small brackets, or instruments can be carried in a bolt bag on the worker's harness. Coveralls or other clothing with cargo pockets that can be securely closed can also be used for carrying small items.

Tools can be suspended from rope grabs, or tied off to a structural member or other secure anchor at the work area. Daisy chains (webbing slings sewn with numerous loops) can be used for keeping gear secured in an orderly fashion at the work area.

Bags or containers used for raising or lowering must be sturdy and able to withstand the abrasion of movement up and down rough surfaces. The use of open buckets and containers is not recommended.



**Carry extras:** a small dropped item, especially when it's a unique part, can result in a lot of wasted time and energy.

### Deploying Ropes for Descent

In many cases, it is best to deploy ropes from bags as the worker descends rather

than deploying the ropes by throwing or lowering them. Some reasons not to throw or lower the rope may include:

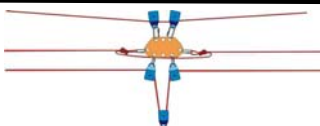
- a. The ropes may get damaged or tangled.
- b. Rocks or debris may be dislodged.
- c. The deployed rope itself may damage physical assets (e.g. buildings, windows, etc.).
- d. The weight of the deployed rope may make it difficult to operate the descent-control device.

Although the weight of some rope lengths can exceed the 22 lbs (10 kg) load requirement discussed in this chapter, it is often not appropriate to use a separate rope system to deploy the ropes. Special precautions must be taken if operating with a rope bag over 22 lbs (10 kg). The rope bag should not be suspended directly from the operative's harness. Rather it should be suspended from the descent-control device itself in such a fashion that the operative can release himself from the system (e.g. to ascend). A spreader bar can be used to keep the rope bags from hitting the worker's legs while descending.

### Power Tools

Special care must be taken when working with electric tools. **Section 12 – Electrical Safety Requirements** of the Reclamation Safety and Health Standards discusses in detail site requirements for using electrically power tools and equipment. Additionally, **Section 17— Hand Tools, Power Tools, Pressure Vessels, Compressors, and Welding** covers Reclamation requirements for safe use of such items. Some additional considerations are outlined here.

All electrical equipment, plugs, sockets, couplers, leads, etc. must be suitable to the environment in which they will be used.



Appropriate grounding must be provided as required. The use of ground fault circuit interrupters (GFCIs) must be standard, especially where wet conditions may be encountered during the work.

Special care must be taken to make sure that connectors between power cords are securely fastened and reinforced as necessary. Since power cords are often free hanging, unusual stress can be put on the connections beyond those applied if the cord were laying on a flat surface.

A suspended worker may need to be anchored locally to manage kickback or torque produced by power tools.

Any power tool that could cause injury to the user or access equipment must be fitted with an automatic shut-off switch that will cut off the power when released by the user.

Where generators are used to power electrical tools, the generator must be equipped with a simple shut-off device to allow quick power-down in the event of an emergency.

If pneumatic tools are used, special rigging of air lines may be necessary to prevent connections from pulling loose due to the weight of the suspended air hoses. If air lines are more than one-half inch in diameter, whip-check devices must be attached to the hose at each connection or splice.

When using pressure-washing tools, measures must be taken to assure the high-pressure nozzles do not come in contact with operator's ropes. Independent ropes and anchorages may be necessary to support the weight of the hoses.

Gasoline-powered tools present other unique challenges. Besides protecting the ropes, slings, lanyards, etc., from sharp

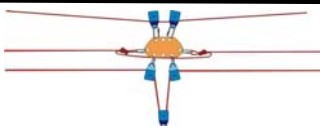
blades and rotating parts, care must be taken that synthetic portions of the rope access system do not come in contact with hot surfaces. Additional care must be taken to avoid contact between oil-based fuels and lubricants and the ropes, slings, lanyards, and harnesses. Gasoline-powered tools may also produce high torques which are easily handled by a standing worker, but may cause difficulty and hazards when the worker is suspended.

Many power tools can easily cut and cause failure of a rope-access system. Special care must be taken in all circumstances where sharp or hot surfaces can come into contact with the rope-access system. Steel lanyards or connections can be used in lieu of rope connections to the worker's access system.

### **Chemicals, Solvents and Adhesives**

Special consideration must be taken when working with chemicals, solvents, and adhesives such as epoxies, cleaning solvents, cement, and paints. Beyond the usual safety and health considerations relevant to the use of these materials, the rope-access supervisor must consider the effects on the synthetic fiber components of the safety system.

Special care must be taken to avoid storing ropes and other synthetic-fiber safety equipment adjacent to chemicals. The fumes of certain chemicals may also have a deleterious effect on this equipment such as ropes stored in a vehicle trunk or equipment trailer where they are exposed to chemical fumes at elevated temperatures.



**LOAD MANAGEMENT**

This part of the chapter addresses the standard operations used to move personnel, material or equipment in a vertical or horizontal plane.

1. Lowering
2. Hauling
3. Cross-hauling
4. Taglines
5. Guidelines
6. Highlines

All of these techniques involve at least one operator stationed near a fixed anchor (Chapter 7). A separate belay (Chapter 9) must be used when personnel may be put at risk if the main load line fails. Single rope systems may be justified in some emergency situations (Chapter 12).

The following general requirements must be met when lowering or hoisting loads:

- a. The load anchor, at a minimum, must be capable of supporting a static load greater than or equal to 3 times the load weight.
- b. Locking carabiners or screw links are recommended for all load connections.
- c. If the load must be raised or lowered over an edge or surface, appropriate edge protection (Chapter 5) must be used to reduce friction and minimize rope wear.
- d. The progress of lowered or hoisted loads over 10 kg (22 lbs) must be controlled by an appropriate progress-capture device (or rope grab).
- e. Multiple-item loads can be packaged in heavy-duty canvas or nylon haul bags. These bags must be designed to carry the anticipated load and must be secured to prevent loss of the load. Multiple attachment points are recommended.

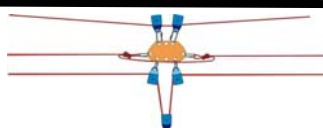
- f. A single-rope system may be employed for tool and material loads under 50 kg. (110 lbs.). A single-rope system may also be used when the potential failure of the system does not pose a significant risk to personnel or physical assets. All human loads must be secured with a back-up safety rope.

**Table 10-1.** Load Management Guidelines

<b>Mass in lbs. (kg)</b>	<b>Considerations</b>
Small bolts, nuts, writing utensils and other misc. items	Use a suitable bag with secure zip/drawstring closures
All tools, materials, and other loads	Tethered at all times
less than 22 lbs (10 kg)	Can be attached to harness
greater than 22 lbs (10 kg)	Separate rope required; Auto-stop or progress capture device required
greater than 110 lbs (50 kg)	Independent anchor system required
less than 550 lbs (250 kg)	Standard rope access gear can be used
greater than 550 lbs (250 kg)	Use specialized lifting equipment

**Communication**

Communications between personnel operating load-management systems and workers on rope must be well established prior to the start of work. Radios, clear hand or voice signals must be agreed upon, and practiced throughout the work.



### Ropes for Load Management

An operative can choose to use a synthetic kernmantle rope system or a wire rope system.

Nylon or Polyester Rope Systems are easily built from the materials and skills commonly used in rope access and rescue systems. Low-stretch kernmantle ropes are recommended for load management. In some cases it is appropriate to use ropes that have been retired from service as life-safety ropes for load management applications. These retired ropes must be clearly identified to avoid confusion and inadvertent use for life-safety applications.

A wire rope system offers increased relative strength and durability over kernmantle rope systems (Figure 10-1). Specialized equipment and training beyond those used in rope access systems are required. Regardless of the type of system, many of the same precautions apply. Do not overload the system!



**Figure 10-1:** Manufactured hoisting mechanism for unlimited lengths of wire rope.

### Lowering Systems

Because lowering systems are assisted by gravity, lowering is generally the simplest and preferred method of moving loads.

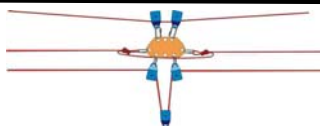
The load can be lowered by the use of a fixed brake (descender) attached to an anchor. A few examples of appropriate lowering devices include a Petzl I'D, Petzl Stop, Figure 8, and a Brake Bar Rack (Figure 10-2).



**Figure 10-2.** Brake bar rack

The lowering of equipment and other loads must be done in accordance with the requirements of Chapter 10, Managing Tools and Materials. Additional considerations include:

- a. Lowered loads must be controlled by an appropriate friction device and correct technique capable of controlling and stopping the load.
- b. If the friction device is not auto-locking and the load is over 22 lbs (10 kg), the friction device must be backed up with a mechanical brake or rope grab.
- c. Loads over 110 lbs (50 kg), but less than 550 lbs (250 kg) can be lowered effectively using many common descent-control devices. Special care must be taken to use the device in the manner intended by the manufacturer. It is often necessary to redirect the rope through a carabiner (attached to the anchor) to provide the appropriate friction and direction of pull (Figure 10-3). The Petzl I'D does not function efficiently for loads under 110 lbs (50 kg)







**Figure 10-3.** Redirecting the rope for extra friction for lowering operations

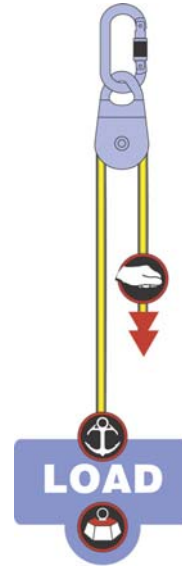
**Raising Operations -- Mechanical Advantage Systems**

Although winches and other mechanical systems can be used to accomplish raising operations, every rope-access technician should know how to employ simple mechanical advantage (pulley) systems to raise personnel, material or equipment.

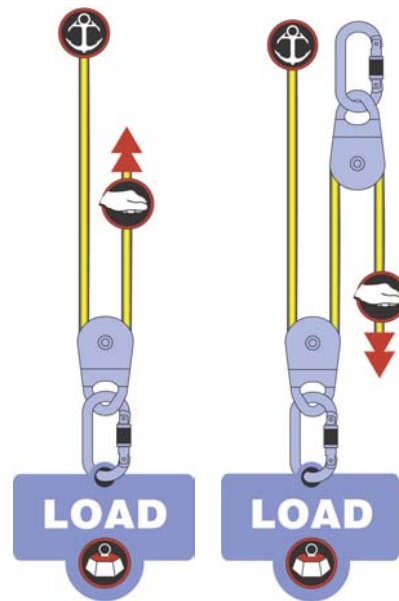
Pulleys are used in MA systems to either (1) change the direction of the rope or (2) create mechanical advantage.

Pulleys that do not move (attached to a fixed anchor), change the direction of the rope but do not create mechanical advantage (Figure 10-4).

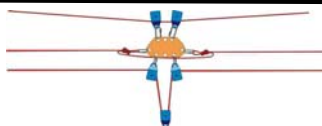
Pulleys that move with the load generally create mechanical advantage. (Figure 10-5 and 10-6)

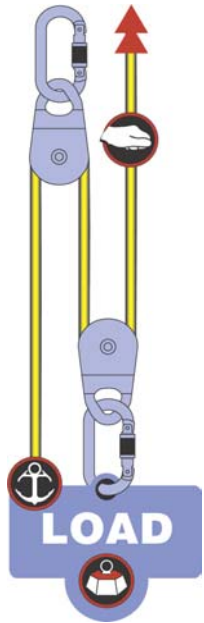


**Figure 10-4.** A 1:1 change of direction system that does not create any mechanical advantage.



**Figure 10-5.** Both systems are 2:1 mechanical advantage systems; a change of direction pulley added on the right.





**Figure 10-6.** Additional moving pulley added to create a 3:1 system. It isn't important to know exactly how much mechanical advantage, but rather how to quickly create more mechanical advantage as needed.

The most reliable way to calculate MA is to measure the distance of rope that is pulled through the system for every unit of distance the load moves.

Example: In a 3:1 system, the user will have to pull 3 meters of rope to raise the load 1 meter.

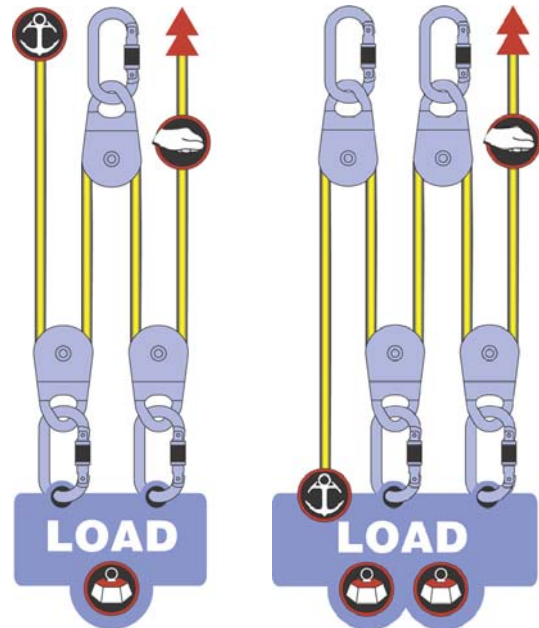
Numerous shortcuts exist for calculating MA that work well. Counting the number of ropes that share the load is helpful. A 3:1 system has 3 ropes sharing the load.

In simple systems, the amount of mechanical advantage can be cross-checked by using the following tip. If the rope terminates at the load, the mechanical advantage is usually an odd

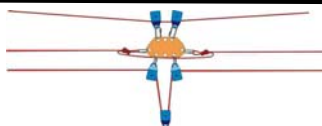
number. If the rope terminates at the fixed anchor, the MA is an even number. For example, the rope terminates at the load in a 3:1 system. These techniques can be used to calculate the mechanical advantage in the systems shown in Figure 11-6.

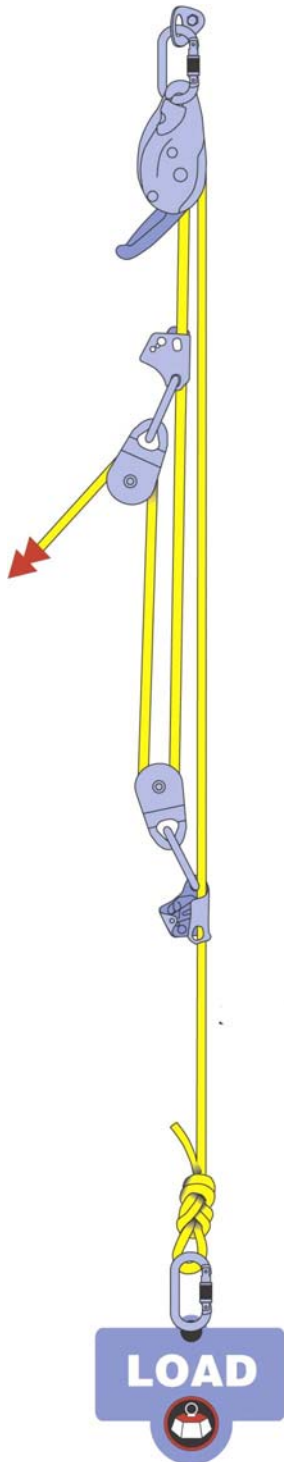
Usually, a braking mechanism is needed to capture the progress made in the raising operation. The mechanism is called a *progress capture device* (PCD). The PCD allows the operator of the hauling system to let go of the haul line for any reason (e.g. reset the system) without losing ground on the operation.

Several tools can be used interchangeably as a PCD. Any rope grab, such as a mechanical ascender, rescue cam, or prusik hitch can be used. An auto-stop descender or belay device can also be used (Figure 10-8). This type of PCD has the disadvantage of adding considerable friction to the system, but the advantage of easily converting into a lowering system.



**Figure 10-7.** A 4:1 (left) and 5:1 (right) mechanical advantage system.





**Figure 10-8.** 5:1 Mechanical advantage (complex system) using auto-stopping descender as progress capture

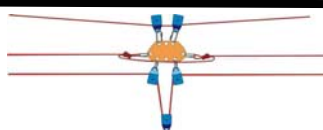
**⚠ CAUTION:** OVER-STRESSING OF ROPES, EQUIPMENT AND CONNECTORS TO FAILURE CAN OCCUR WHEN USING MECHANICAL ADVANTAGE SYSTEMS. RAISE SLOWLY AND STOP IF THE EFFORT REQUIRED CHANGES. DETERMINE THE CAUSE BEFORE CONTINUING THE RAISING OPERATION.

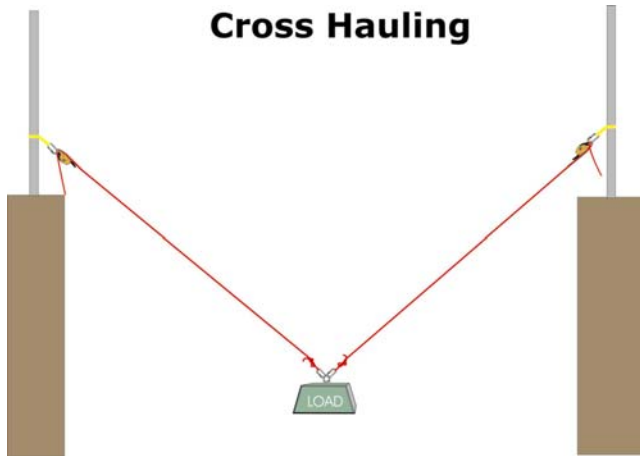
**Moving Equipment Horizontally**

Occasionally loads must be transported in the horizontal as well as vertical axis. There are at least four common methods that can be used to accomplish the horizontal movement:

1. cross-hauling
2. tag-lines
3. guide lines
4. high lines.

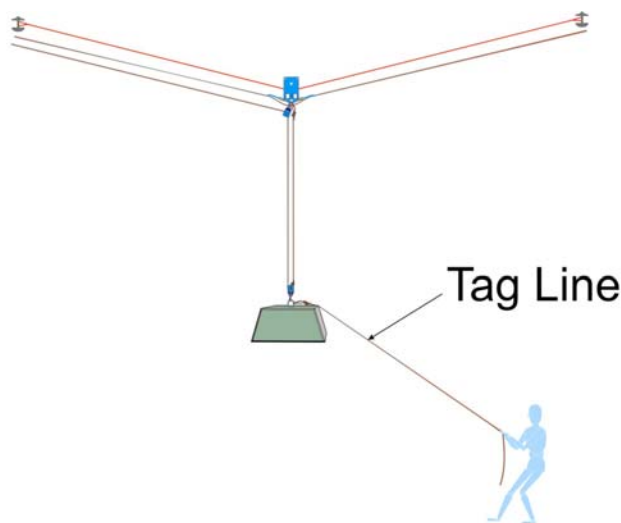
**Cross-hauling** involves setting up two or more rope systems attached to anchors separated by a horizontal distance. The system allows the operator(s) to move the load in a two-dimensional plane with two ropes and a three-dimensional plane with three ropes. (Figure 10-9) The system may need to be operated by more than one person and it can be used to lower and raise equipment when used in conjunction with a lowering or hauling system.





**Figure 10-9.** Cross hauling: the load is managed by adjusting ropes between two or more anchors

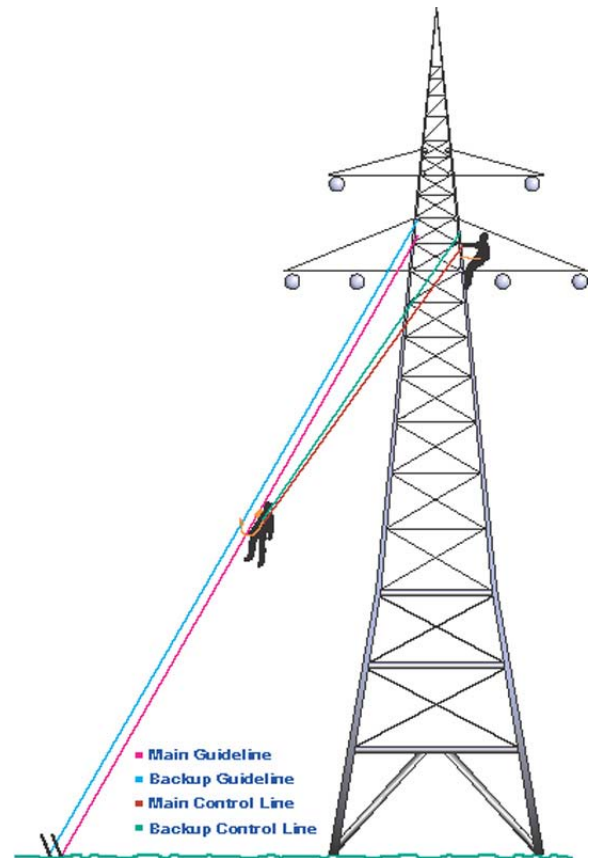
**Tag Lines** can be attached directly to the load to help manage the load around obstacles. A remote operative can pull on the tag line to help negotiate the load away from the obstacle or the side of the structure. While tag lines are simple to use, it is often difficult to control the load precisely.



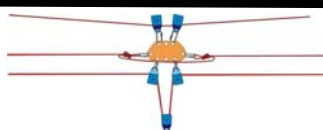
**Figure 10-10.** Tag line on a load

**Guide Lines** (Figure 10-11) are used for moving people, tools, and materials in both a horizontal and vertical plane. These systems are quite similar to highlines, however the forces transferred to the anchors are considerably lower.

The guideline is tensioned in a similar fashion to a highline (Figure 10-12). In addition to the guideline a working line in conjunction with a raising or lowering system is employed to move the load. A back-up safety line for both the guide line and working line is appropriate if the guide line is being used for human loads. A single guideline and single highline may be adequate for moving materials or some emergency situations.



**Figure 10-11.** Guideline used for a tower rescue.



**High lines** are similar to guide lines, but the two anchors are generally at or near the same elevation. Highlines are constructed from kernmantle or wire rope. High lines can be used to move personnel and materials over deep valleys or structures, or may be used when the load cannot be lowered from directly above the work area. A high-line system can also be combined with a lowering or hoisting operation.

Highlines typically take considerably more rigging than other techniques and should be thoughtfully considered and then practiced prior to use in the field. Time spent in team practice usually results in considerable time saved during field work, and may be critical if a high line is needed for a rescue.

### High Line Components

The primary line which supports the load is referred to as the **main line**. Where two main lines are used, care should be taken to assure that both lines are tensioned and maintained as equally as possible. Low-stretch or static ropes should be used for all high lines.

The **static anchor** is the fixed end of the high line. A high-strength tie-off should be used to attach the main line to the static anchor to conserve to full strength of the rope. If such a tie-off is not possible, a large-diameter pulley such as a Petzl Kootenay, can be used with the sheave secured with the pins inserted through the pulley sideplates. Once the pulley is well-secured, attach the main line rope using a tensionless hitch.

The **tensioning anchor** is the end of the high line where the tensioning system is located. This area will usually require more space to array and operate a mechanical advantage system and room for the team to work.

The **tensioning system** (Figure 10-12) is the mechanical advantage arrangement used to apply tension to the main line. The tensioning system should not weaken the main line.

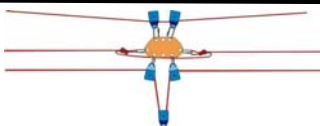
The **main pulley** or carriage carries the load and travels along the main line. Multiple pulleys may also be used in conjunction with a rigging plate (see Figure 10-14) to form the carriage and allow multiple tag lines and haul lines to be easily attached. Large pulleys or those with fixed tandem arrangements (such as the Petzl tandem) should be used to reduce the amount of friction generated by the carriage moving along the main lines.

**Tag lines** are the ropes that run from either side of the carriage to the anchors at each end of the high line system. Where the tag lines also serve as the backup line, they must be kept free from slack. They should be attached to the carriage with prusiks to allow strain relief in the event of the failure of the main line. These lines can also serve as raising or lowering systems depending on the direction the load needs to move.

**Haul lines** are the ropes used to raise and lower loads in Reeving high line systems. These lines will be equipped with mechanical advantage systems and lowering systems as needed.

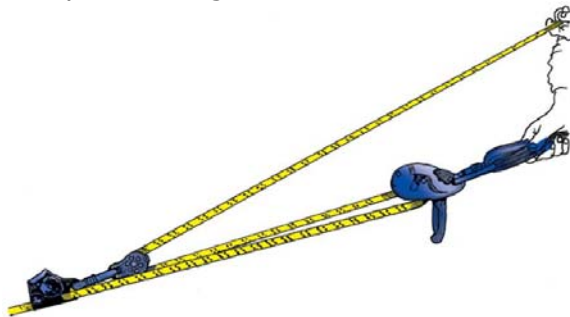
A few considerations for the use of high-lines for load management include:

- a. High lines for load management can be built with synthetic fiber ropes for lighter loads, or wire rope for heavier loads.
- b. Very high forces can be exerted on a high-line system due to low angle-loading. Angles of 160 degrees or more will result in loads of **300%** or



more of the actual load (Figure 10-15.)

- c. When tensioning high lines, take care not to pull the lines so tight that, when loaded, the tension of the lines exceeds the strength of the components.
- d. Load limiting devices (such as an auto-lock descender) or systems may be installed in the high lines to assure that overloading of the system does not occur.
- e. Where wire ropes are used for high lines, all hardware must be designed for compatibility with wire rope systems including pulleys, hoists, wire rope grabs, shackles, thimbles and wire rope clamps.
- f. Handling of very heavy loads (greater than 550 lbs (250 kg) shall be done only on systems designed by an engineer proficient in such rigging.
- g. High-lines should be arranged such that materials, equipment, etc. are not lowered directly over personnel working below.
- h. Load cells can be purchased and installed at the high line anchors. Monitoring of the load cells can assure loads do not exceed those of the system design.



**Figure 10-12.** Tensioning system for guide line or high line. The locking

descender (Petzl I'D) can serve as a load limiter in the system.

### **Anchors**

Anchors in high lines can be subjected to high loads. Select anchors with considerable care. Load distributing anchors should be employed if there is any question to the integrity of a single anchor point. (Refer to Chapter 7 – Anchors).

Generally, place high line anchors as high as practical to allow sufficient clearance for loads. It may be necessary to provide a secure directional pulley, or erect an A-frame to gain adequate height for the system before tensioning the main line.

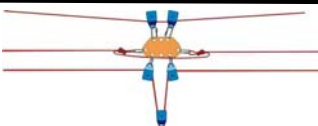
Take care in how the load is applied and secured to the anchors. Various authors state that it's important to avoid any knots in the main line, or rope grabs that may damage the rope (such as Gibbs Ascenders) High strength tie-off knots (Figure 9 knot or tensionless hitch) may be used at one end of the main line, but the other end must have some type of tension release such as prusik knots or a belay device that will slip prior to rope damage. Where prusik knots are used, they should always be configured in tandem and be three-wraps. Most rescue teams employ 8mm cord for this type of loading.

### **High Line Types**

There are two basic types of high lines: A Kootenay and Reaving High Line.

The Kootenay high line is tensioned after the load is applied. The load is raised or lowered in the span by releasing the tension of the main line.

On a Reaving high line, the mainline is pre-tensioned then the load is lowered or lifted in mid-span by the use of pulleys



and secondary ropes.<sup>2</sup> These two basic types can be configured in several ways (Figure 10-13 and 10-14)

Systems for personnel must always have a secondary or backup rope installed in the rigging. The backup can be incorporated in the tag lines, but both ends of the tag lines must be secured with a load releasing device or hitch.

Since high lines deal with loads imposed on rope systems suspended between points at very low angles, there is a very real potential to overload equipment and anchors possibly causing a system failure.

Limiting the tension on high lines is necessary to stay within acceptable safety factors. The flatter the angle formed by legs of the system, the greater the load imposed on the anchors (see Figure 10-15).

Different types of load limiters can be installed in the system that will slip prior to failure of the rope. Prusik knots, Petzl Grigris, I'Ds, or Shunts can be placed within the system to assure that if the system is overloaded slippage will occur before failure. These devices, if thoughtfully installed can also allow release of rope tension to make adjustments in hauling and positioning

### Rules for Tensioning

Various systems are used to estimate loads on high lines in order to limit the force applied to anchors and equipment. One of the simplest and practicable for most work seems to be the Number of

Persons Rule<sup>3</sup>. If you can estimate the amount of force exerted by each person and then multiply it by the mechanical advantage used, the tension in the high line system can be calculated.

Based on empirical testing, the average person exerts about 100 lbs of force when pulling with a glove hand and moderate effort.

For 11mm (7/16") rope in order to maintain about a 5:1 system safety factor, it is recommended to limit the load to 1200 lbs of force, or 12 people. For 12.5 mm (1/2") rope the factor is 18 people or 1800 lbs. Thus when 6 people are tensioning an 11mm rope no more than a 2:1 mechanical advantage should be used:

$$6 \text{ people pulling} \times 2 \text{ (2:1 mechanical advantage)} = 12$$

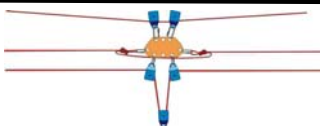
When 4 people are pulling, up to a 3:1 can be used:

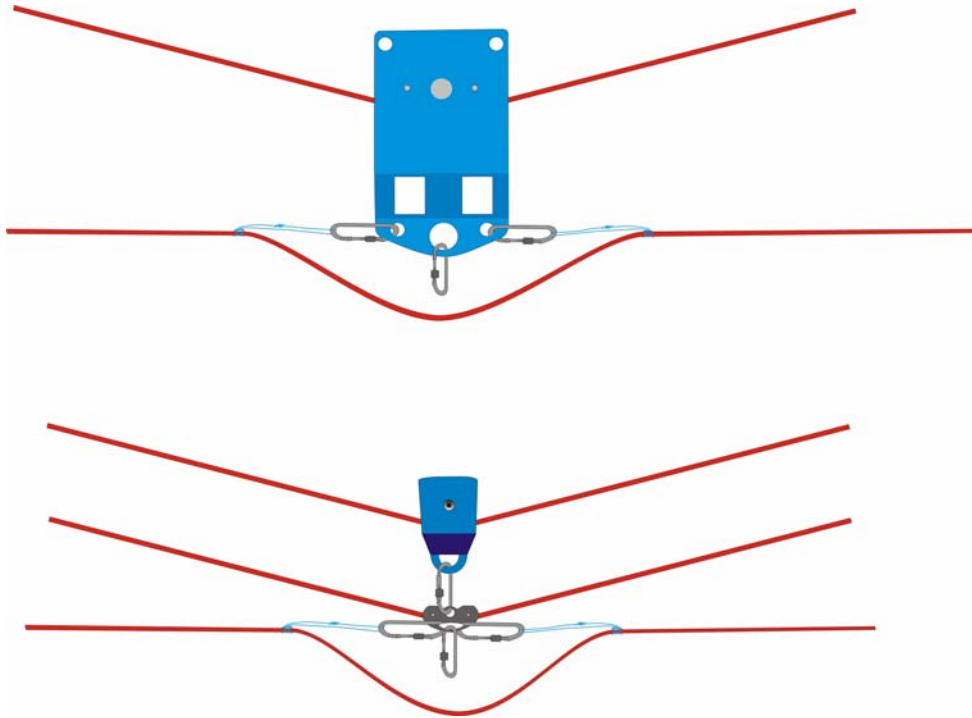
$$4 \text{ people pulling} \times 3 \text{ (3:1 mechanical advantage)} = 12$$

Obviously where wire rope is used for the main lines, different tensioning schemes must be applied. Care should be taken to assure that even with wire rope that the strength of the system is not exceeded. When possible, the use of a dynamometer in the tensioning system can assure that the tension doesn't go beyond the strength of the components.

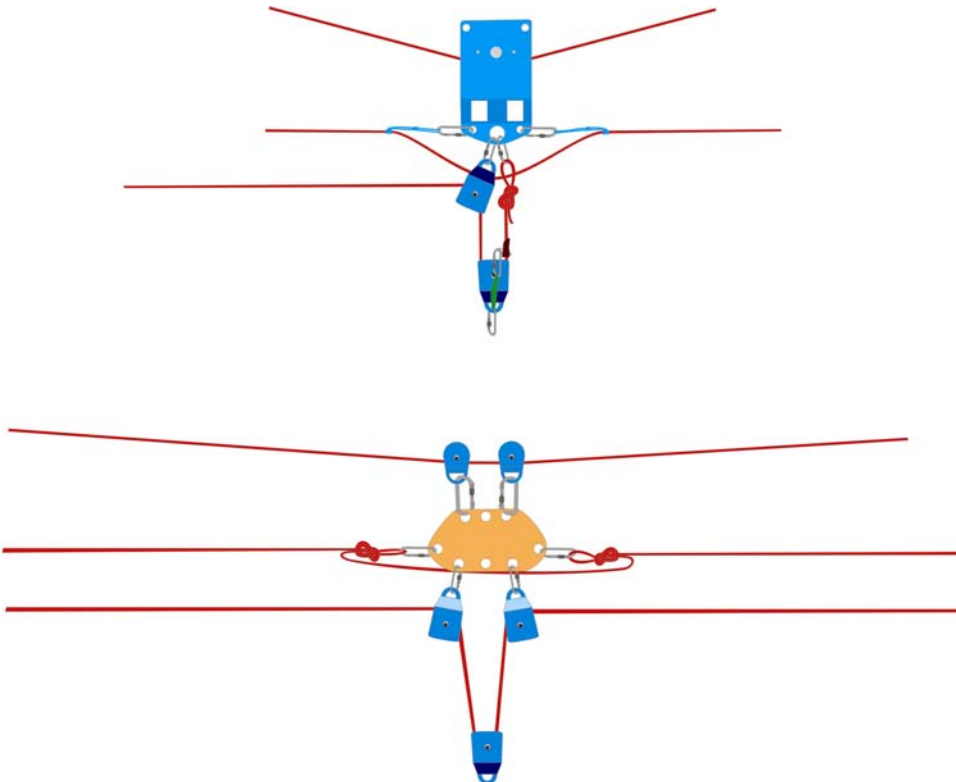
<sup>2</sup> CMC Rope Rescue Manual, 1998, edited by James A. Frank, CMC Rescue, Inc., 208 pages.

<sup>3</sup> Padgett, A., Smith, B., 1997, On Rope, 2<sup>nd</sup> edition, Huntsville, AL, National Speleological Society

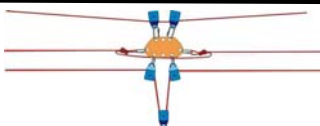




**Figure 10-13.** Examples of Kootenay high lines



**Figure 10-14.** Examples of Reaving high lines

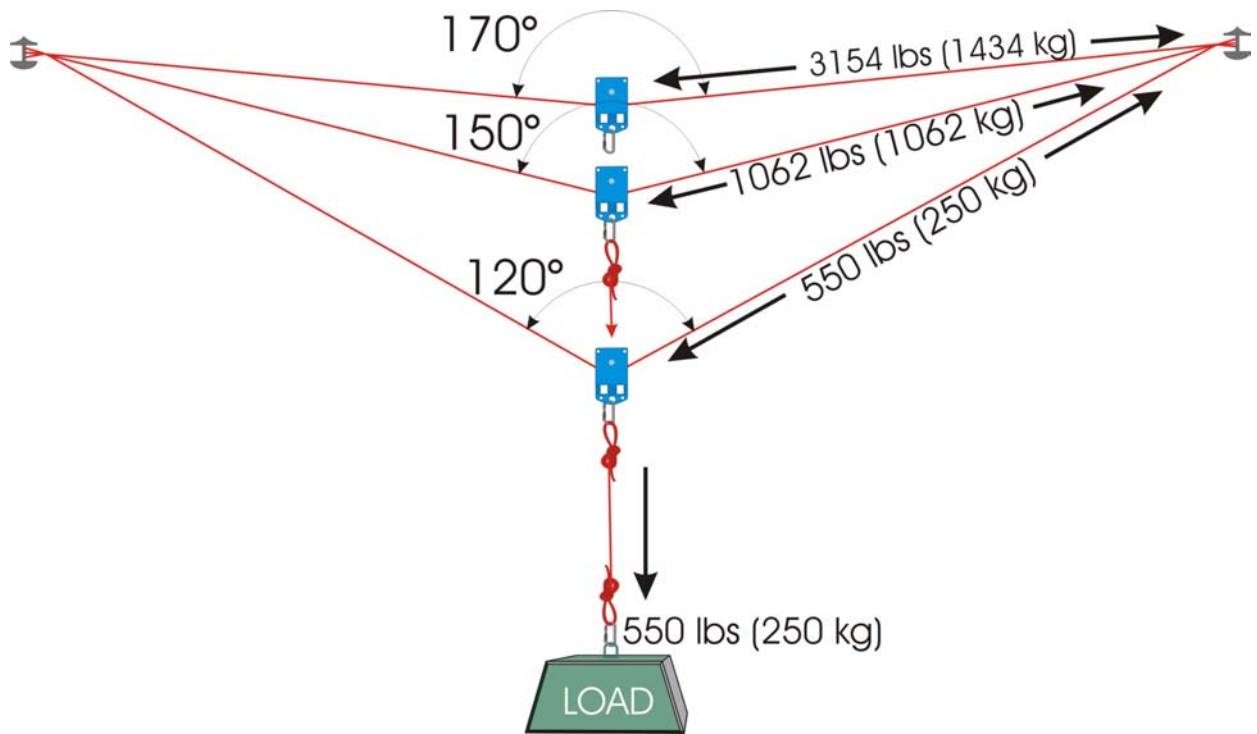




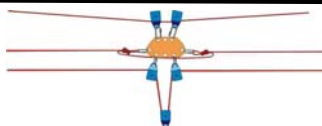
**Managing the System**

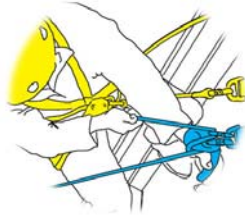
Nearly all high lines require multiple personnel to operate efficiently. Where the load is lifted by tensioning the main lines, as in the Kootenay high line, exercise care to tend both the main lines and the tag lines as the weight of the load is shifted onto the system. Team members must continue to tend all of the

lines during lifting and transport to assure that a sufficient backup is maintained at all times. Good communications are always important whenever several must work together to manage loads. Be especially attentive if the load becomes entangled or snagged along the way as pulling hard on the mechanical advantage systems can severely load the main lines.



**Figure 10-15.** Diagram showing increasing loading with increasing angles between the legs of the high line





## Chapter 11. Rescue Protocol

### Overview

Being prepared for an emergency is common sense as well as a legal requirement in most jurisdictions. State and federal Health and Safety regulations usually state the following: "*The employer shall provide for prompt rescue of employees in the event of a fall or assure the self-rescue capability of employees*". OSHA in California, for example, requires all employees using rope access to receive rescue training on an annual basis.

Most accidents requiring an emergency response are preventable. The majority of this manual outlines safe practices designed to keep an accident from occurring in the first place. Nevertheless, emergencies can occur. Emergencies result from medical problems, environmental conditions, equipment failure, and human error.

### The Rescue Plan

A rescue plan must be outlined during the overall job planning and hazard analysis phase before work begins. The main objective of a rescue plan in industry is to safely move the casualty from the structure or otherwise inaccessible location to a place where the emergency medical system can administer definitive care. This process must occur in a timely fashion without further endangering additional people or the injured party. The rescue plan (part of the job hazard analysis) must do the following:

- Designate a rescue response leader and alternate
- Identify resources, capabilities and response time of emergency medical system (EMS)

- Communication between team members, facility management, and the EMS
- Best locations to transfer patient to EMS personnel
- Type of rescue operations needed (hauling, lowering, guidelines, etc.)
- Number of people needed to perform a potential rescue
- Special equipment and anchors needed for rescue operations

### Safety Meeting

Before work begins, each person in the team needs to be briefed on the potential hazards of the worksite and the specifics of the rescue plan. Communication equipment must be tested, potential rescue scenarios discussed, anchors for potential rescues identified and/or prepared. Rescue equipment must be easily accessible and the approach for emergency vehicles cleared.

### Speed and Efficiency

Time is a crucial factor that determines the success of many rescues. An unconscious casualty that remains hanging in a harness may suffer life-threatening consequences in as little 20-30 minutes. A conscious patient that sustains traumatic injury may need attention even sooner.

Given the urgency required, the EMS system must not be relied upon for the initial high-angle response. The local jurisdiction may not have efficient rope-rescue capabilities. In most cases, even the best prepared outside agency cannot mobilize a technical rescue in the time required. The rope-rescue capabilities must be available on site. In most cases,

the rescue responsibility lies within the rope-access team itself, however, any rescue effort must be coordinated with the professional emergency services.

The need for a speedy response must not compromise the safety of the rescuers, bystanders, or the casualty. If a rescue is necessary, precious moments must be spent assessing the situation and coordinating the efforts of the rescuers.

### **Training And Practice**

Rescue skills are not used regularly during the course of work and therefore must be practiced often to insure that an emergency response can be performed systematically and efficiently when needed. It is a good habit to practice rescue skills specific for each job prior to performing work. The potential rescue must be discussed with all personnel on site. Rescue anchors and potential complications must be identified.

### **Leadership And Supervision**

Properly qualified Supervisors (Team Leader) play a key role in accident prevention and emergency response. The Supervisor's responsibility is to ensure the safety of the entire jobsite and to coordinate the efforts of the rescue response in the event of an emergency. When multiple technicians are on site, the Supervisor should avoid working on rope as this may distract attention from supervision responsibilities. During a rescue effort, Supervisors need to be especially aware of how to best maximize the efforts of the entire team. The rescue plan must identify an alternate rescue response leader in the event the Supervisor is implicated in the problem. The Supervisor, or a designated rescue response person, must be geared up and ready to respond at all times when workers are on rope.

### **Suspension Trauma**

Suspension Trauma, or Harness-induced Pathology (HIP), is a life-threatening condition that can arise when a motionless or unconscious patient is left suspended upright in a seat or body harness.

A conscious and active person working while suspended in a harness will move his or her legs regularly. This motion facilitates the efficient return of blood from the legs to the core organs.

In a suspended unconscious patient, blood pools in the legs and eventually causes circulatory distress and dangerously low blood pressure, depriving the core organs and brain. The pressure of the harness on the femoral arteries and veins contributes to the problem.

Recent data suggests that a life-threatening condition can occur in as little as 20-30 minutes of suspension. Further complications arise when a patient is moved suddenly from an upright suspended position to level ground. Cardiac arrest has been attributed to the sudden circulation of accumulated toxins from the legs. Some effects can even become visible after several hours.

Several important lessons concerning managing suspended unconscious patients can be drawn from this information:

1. Rapid retrieval of the patient is critical.
2. In most cases, the rescue must be initiated by the work crew.
3. Relieving the pressure of the harness and facilitating some movement of the legs must be accomplished as soon as possible.
4. The patient should be placed in a horizontal position gradually once retrieval has occurred.
5. Patients must always be transported to a hospital for medical care where HIP is possible!

Note: A detailed report regarding Suspension Trauma compiled by Paul Seddon is available from UK's Health and Safety Executive (see resources).



## The Rescue

1. **Assess the situation.** Before beginning any rescue operation, the cause of injury must be identified to avoid further injury to responding personnel. Try communicating with the patient. Attempt to ascertain the seriousness of the patient's injuries. Identify the location of casualty and the logistical challenges that might be encountered during the rescue. What tools and resources will be needed?



If the conditions that caused the emergency are still present (e.g. toxic gas, rock fall, electrical hazard, etc), do NOT send additional persons to the site of the accident. A remote retrieval should be considered.

2. **Stabilize the casualty.** In most cases, the rescuer should attempt to reach the casualty to administer first aid, unless it is impractical, unnecessary, or dangerous to do so. Stabilize the patient's position and address airway obstructions or major bleeding immediately. If spinal injury can be suspected, appropriate precautions must be taken. Spinal immobilization, while not impossible, is difficult to accomplish while suspended. Given the risks associated with suspension trauma, it is often prudent to place a C-collar on the patient and proceed with an efficient evacuation to a location where more definitive measure can be taken.
3. **Extricate and transfer the casualty.** The casualty's ropes can be used for access and evacuation in some scenarios. Other rescues require the use of independent ropes. Usually the patient needs to be transferred onto the rescue system. This might involve releasing the casualty's descender or setting up a mechanical

advantage system to raise and lower the casualty onto the rescue system.

4. **Evacuate the casualty.** The casualty may need to be raised, lowered and/or transferred across a diagonal or horizontal tracking line. Lowering is generally the best option because lowering involves less complicated and gravity assisted systems.
5. **Transfer casualty to definitive medical care.** Additional patient care, spinal immobilization, and wound management may be needed prior to transferring patient to definitive medical care. Patient must be transferred to professional medical personnel as soon as possible.



Cutting the patient out of their system is an option; however extreme caution must be used. Sharp objects are always a concern around tensioned ropes. The subsequent shock loading of the rescue system can be expected. The use of an adjustable pick-off strap can mitigate this concern.

### Two-person Loads

In many cases, a rescuer may need to attend the patient to negotiate obstacles, stabilize the patient, or monitor the patient's condition. If the rescue plan calls for attending the patient, the system must be evaluated for its ability to safely handle a two-person load. This evaluation must be done prior to beginning work. It is generally preferable to lower or retrieve the patient without putting another person on line if it can be done efficiently and safely.

### Belaying: Two-rope Technique vs. Single-rope Technique (TRT vs. SRT)

Two-rope systems are used in most industrial rope access applications. It is standard protocol to provide a belay for rescue operations through an attended belay or the rescuer's self-belay. There



are circumstances where logistics or the condition of the casualty may justify using SRT. Caution and prudence is warranted.

Most tower rescues involving single person loads, for example, are most efficiently carried out using single rope techniques. The additional complication and weight of multiple lines cannot be justified if they must be hauled up into a tower by a single rescuer.

Live loads used during rescue training must always be belayed with a separate rope system! Remember that some common belay methods are inadequate for belaying two-person loads.

**Evacuation Skills**

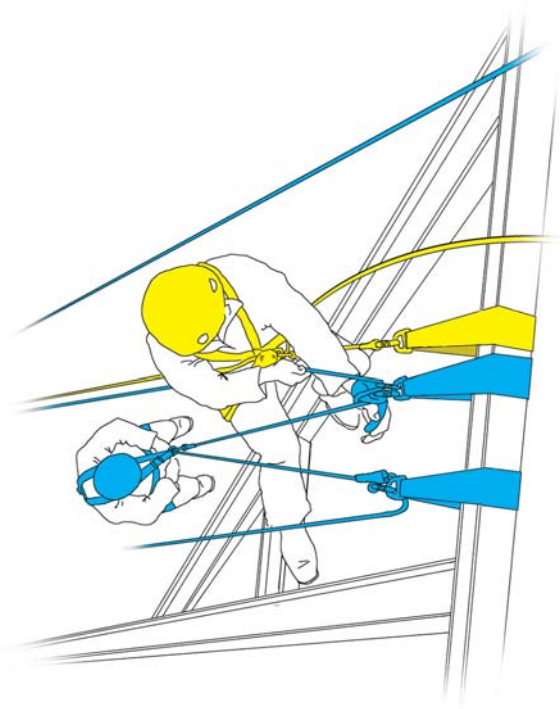
The location of the casualty relative to the best place to deliver more definitive medical care determines the method of evacuation. Rope-rescue methods usually involve lowering, hauling, or a pick-off by the rescuer. A tracking line can be used in conjunction with these methods to direct the path of the rescue.

**Lowering Operations**

Lowering is usually the preferred method of evacuating the casualty because the system is the least complicated and gravity assisted. The casualty is transferred from the existing suspension system to a lowering system controlled by the rescuers. An appropriate descending device connected to a fixed anchor is used to control the lowering operation.

The lowering system must be backed up with an attended belay unless the use of a single-rope system can be clearly justified.

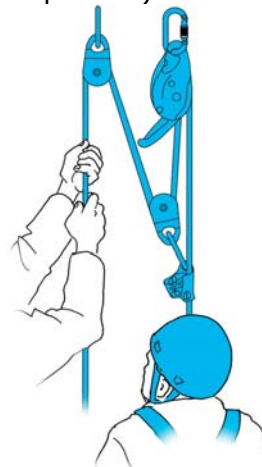
**Note:** Descenders used for rescue operations may require extra friction, as recommended by the manufacturer, especially when two-person loads are considered. Often, even single-person loads require the use of additional friction if the device is used in a vertical orientation.



**Figure 11-1.** Rescue by Lowering

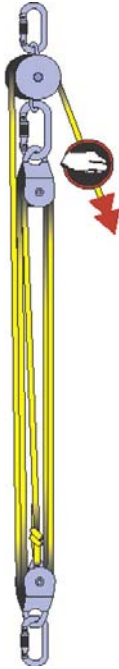
**Raising Operations -- Mechanical Advantage Systems**

Sometimes it is necessary to evacuate the casualty using raising operations. This is usually accomplished using mechanical advantage (MA) pulley systems. MA systems can also be used during work for raising equipment and materials (see Chapter 10).



**Figure 11-2.** Auto-stop descender used as a progress capture device in this 3:1 system. The direction is changed for additional leverage.





Pre-rigged rescue systems have their place in industrial work; however, all advanced rope access personnel must know how to build mechanical advantage systems from basic components. It is risky to rely solely on pre-rigged rescue systems because it is possible for the rescue rig to be tangled, or ineffective for the given situation. Also, keeping the rescue kit close-at-hand at all times may be difficult. It is best for personnel to be trained to use the minimal equipment needed for performing rope access work.

**Figure 11-3.** Pre-rigged rescue system

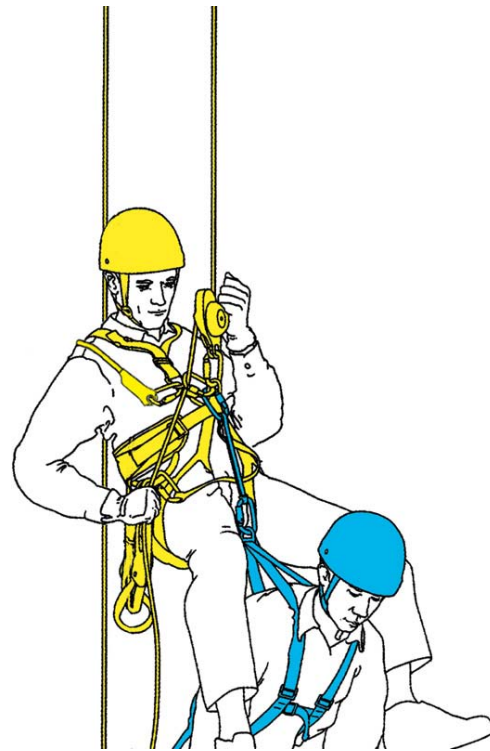
### **Rescue Pick-off**

The pick-off rescue can be the most efficient method of evacuating a casualty in some circumstances. In a "pick-off" rescue, the rescuer generally descends with the casualty attached to the rescuers system (Figure 11-4).

Because the rescuer can put himself, as well as the casualty at risk while performing a pick-off, the rescuer must have extensive training in this type of operation.

The rescuer can choose to reach the casualty using the casualty's ropes, or a separate set of rescue ropes. The rescuer must carefully assess the condition of the casualty's ropes before using them.

If the casualty is suspended from an ascender or directly from an anchor, a brief raising operation is the best way to safely transfer the casualty from his system to the rescue system.



**Figure 11-4.** Example of a pick-off rescue.

### **Using a Knife**

All personnel should carry a knife in case of an emergency. This knife may be used to disconnect a casualty from the safety system. The use of a sharp knife during a rescue operation can be extremely dangerous; therefore, a raising operation is advised instead.

### **Rigging to Lower**

If the rescue plan calls for lowering the casualty in the event of an emergency, pre-rigging the rope-access system to facilitate lowering is often a good idea. Each rope should be twice the length required to service the job. The mid-point of the rope is then attached to the anchor with a load-releasing hitch (e.g. Munter-mule in Chapter 6) or appropriate descent control device (i.e. I'D, brake bar rack, etc., see Chapter 5). All of these methods must be tied off properly!



### **Patient Packaging and Rescue Litters**

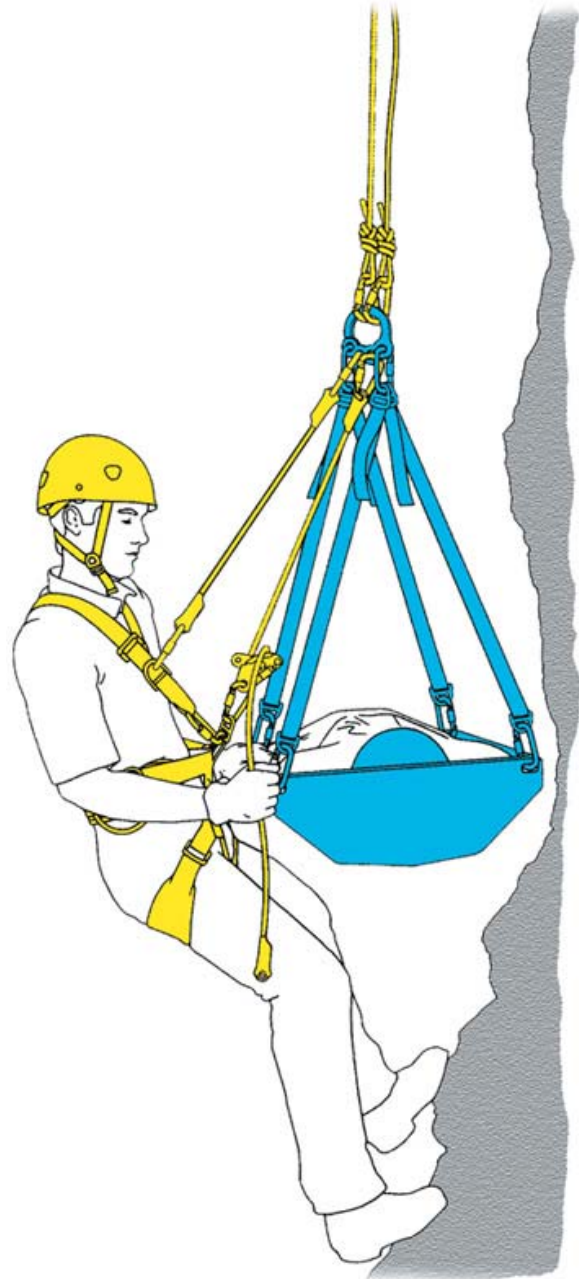
The rescue litter serves to immobilize and protect the patient during transport. A litter should be used whenever practical and appropriate. The use of a litter while evacuating a casualty suspended in their harness may not always be practical. If a patient is suspended and unconscious, the most pressing medical condition will likely involve the lack of blood circulation due to suspension trauma (Page 11-2). Proper patient packaging should not be ignored, however, the rescuer should make every effort to stabilize and return the patient to the ground as soon as possible so that definitive care can be administered. This may require foregoing a litter. Adjustable C-collars for neck stabilization can be useful.

### **The Rescue Kit**

The team's rescue kit must take into account the potential hazards, the team's training, and the availability of outside emergency resources. The rescue kit contains technical rope rescue equipment, first aid supplies, and patient packaging.

**Personal Rescue Kit:** The necessary tools to carry out some basic rescues must be carried by every rope access technician. This equipment should be kept to the bare essentials, otherwise it will be left behind or hinder the work to be performed. With proper training, most rescues can be carried out with a few pieces of additional gear. Each technician may consider keeping a personal first aid kit in their own bag. Beyond the standard rope access kit, the technician might carry:

- Small single and double pulley
- Webbing
- 2 rope grabs or prusik loops
- Spare carabiners
- Knife
- Tape (duct or medical tape)



**Figure 11-5:** Rescue Litter



**Team Rescue Kit:** The team kit includes technical gear to carry out more complicated technical rescues and patient packaging and first aid supplies. A team rescue kit should include:

- Rescue Bag clearly marked
- First Aid Kit
- Rope(s) – ready to deploy
- Pulleys – double, single, and twin pulleys (Figures 11-6, -7)
- Rescue Cams and/or prusik loops
- Carabiners (approx. 10)
- Straps
- Friction-reducing edge protection (roller or plastic, see Figure 11-8)
- Rigging Plate
- Patient litter and packaging



**Figure 11-8.** Plastic edge protection



**Figure 11-6.** Double Pulley



**Figure 11-7.** Twin Pulley





## Job Hazard Analysis (JHA) & Rope-Access Work Plan

Project Name		Date Prepared	
Client/Host		Start Date	
Location Description		Finish Date	
Host Facility Manager		Phone email	
Host Facility Operator		Phone email	

### Personnel

Position	Name Sign only after reading	Contact phone/email	Training Current <input type="checkbox"/> Y <input type="checkbox"/> N	Emerg. Form (on location) <input type="checkbox"/> Y <input type="checkbox"/> N
Prepared by			<input type="checkbox"/> Y <input type="checkbox"/> N	<input type="checkbox"/> Y <input type="checkbox"/> N
Safety Supervisor			<input type="checkbox"/> Y <input type="checkbox"/> N	<input type="checkbox"/> Y <input type="checkbox"/> N
Technician			<input type="checkbox"/> Y <input type="checkbox"/> N	<input type="checkbox"/> Y <input type="checkbox"/> N
Technician			<input type="checkbox"/> Y <input type="checkbox"/> N	<input type="checkbox"/> Y <input type="checkbox"/> N
Technician			<input type="checkbox"/> Y <input type="checkbox"/> N	<input type="checkbox"/> Y <input type="checkbox"/> N
Technician			<input type="checkbox"/> Y <input type="checkbox"/> N	<input type="checkbox"/> Y <input type="checkbox"/> N
other			<input type="checkbox"/> Y <input type="checkbox"/> N	<input type="checkbox"/> Y <input type="checkbox"/> N
other			<input type="checkbox"/> Y <input type="checkbox"/> N	<input type="checkbox"/> Y <input type="checkbox"/> N
other			<input type="checkbox"/> Y <input type="checkbox"/> N	<input type="checkbox"/> Y <input type="checkbox"/> N

### Emergency Information

EMS Phone		Police Phone	
Fire/Rescue Team Phone		Company Contact Name & Phone	
Emergency Access to Site	Where and how will EMS reach the worksite?		
Communication: <input type="checkbox"/> Cell Phone (Check service on site <input type="checkbox"/> Y <input type="checkbox"/> N) <input type="checkbox"/> Radio (Channel: ) <input type="checkbox"/> Phone (Note phone number, location, special dialing, other contacts, etc)			



## Work Plan

Description of Work	
Rope-access Methods	<input type="checkbox"/> Standard practices outlined in Guidelines for Rope Access Work
Individual Equipment	<input type="checkbox"/> Helmet <input type="checkbox"/> Eye protection <input type="checkbox"/> Foot protection <input type="checkbox"/> Gloves <input type="checkbox"/> Protective clothing <input type="checkbox"/> Reflective Clothing <input type="checkbox"/> Respiratory protection <input type="checkbox"/> Hearing Protection <input type="checkbox"/> Harness <input type="checkbox"/> Connectors <input type="checkbox"/> Descender (I'D) <input type="checkbox"/> Belay Device (Gri-Gri) <input type="checkbox"/> 2 Backup Devices <input type="checkbox"/> Lanyards <input type="checkbox"/> Pulleys  <input type="checkbox"/> headlamp <input type="checkbox"/> Multi-tool <input type="checkbox"/> other
Group Equipment	<input type="checkbox"/> Ropes (length and quantity) <input type="checkbox"/> Edge Protection <input type="checkbox"/> Rigging Straps <input type="checkbox"/> Connectors <input type="checkbox"/> other
Team Communication	<input type="checkbox"/> Visual (Hand Signals) <input type="checkbox"/> Verbal (unassisted) <input type="checkbox"/> Radio (Note Channel)
Machinery Lock-out/tag-out	Do machinery, valves, or gates need to be locked-out? <input type="checkbox"/> Yes <input type="checkbox"/> No <input type="checkbox"/> Machinery Locked-out/Tagged out of service <input type="checkbox"/> Hold Order visually checked by RA Supervisor <b>Hold Order Number</b> _____ <b>RA Supervisor</b> _____
Equipment/Tool Management	<input type="checkbox"/> Other...(describe... attach additional pages if necessary)
Access Zone	Describe Access Zone and method to mark and secure entry
Hazard Zone	Describe hazard zone and method to mark and secure entry and to protect public or other workers
Anchors	<input type="checkbox"/> Standard anchors outlined in Guidelines

Rescue and Retrieval Methods	
Rescue Kit	<input type="checkbox"/> First Aid Kit <input type="checkbox"/> Patient Packaging <input type="checkbox"/> Pulleys <input type="checkbox"/> Rope Grabs <input type="checkbox"/> Connectors <input type="checkbox"/> Spare Equipment <input type="checkbox"/> other...

	Condition	Description of Hazards	Control Measures
<input type="checkbox"/>	<b>Water</b> (working around/over moving/standing water)	<ul style="list-style-type: none"> <li>Wet surfaces can be slippery</li> <li>Potential for Drowning</li> <li>Trapped in current while tied off (drowning hazard)</li> </ul>	<input type="checkbox"/> Stop work if conditions become dangerous <input type="checkbox"/> Rescue boat shall be readily available if working directly over water, especially if descent is a viable method of egress. <input type="checkbox"/> Fall protection or rope access equipment must not allow worker to fall into water (especially moving water) <input type="checkbox"/> Personal flotation devices not required if proper fall protection in place
<input type="checkbox"/>	<b>Sun/Heat</b>	<ul style="list-style-type: none"> <li>Possible dehydration, heat exhaustion or heat stroke</li> <li>Burns from tools, equipment, and structural steel</li> <li>Adhesives and first-aid supplies may be degraded by heat</li> </ul>	<input type="checkbox"/> Stop work if conditions become dangerous <input type="checkbox"/> Ample water and/or electrolytes must be on hand for workers <input type="checkbox"/> Schedule proper breaks and work in morning or evening to avoid peak temperatures <input type="checkbox"/> Wear gloves and proper clothing to protect hands from hot surfaces <input type="checkbox"/> Use and frequently re-apply adequate sunscreen
<input type="checkbox"/>	<b>Cold/Freezing Temperatures</b>	<ul style="list-style-type: none"> <li>Possible hypothermia, frostbite, loss of dexterity in extremities</li> <li>Decrease in efficiency, adhesives and first-aid supplies may not function properly due to cold, water for drinking and work may be frozen; slippery surfaces</li> </ul>	<input type="checkbox"/> Stop work if conditions become dangerous <input type="checkbox"/> Wear proper footwear and clothing, including gloves and hat <input type="checkbox"/> Warm liquids should be available to workers
<input type="checkbox"/>	<b>Wind</b>	<ul style="list-style-type: none"> <li>Possible increased cooling or hypothermia risk, increased dehydration risk in dry humidity</li> <li>Decrease in efficiency, hindrance to communications between team members</li> <li>Danger of unsecured equipment or material being blown into the access zone</li> <li>Difficulty communicating</li> </ul>	<input type="checkbox"/> Stop work if conditions become dangerous <input type="checkbox"/> Wear proper footwear and clothing, including gloves and hat <input type="checkbox"/> Secure loose materials at work site <input type="checkbox"/> Be wary of wind developing slack in ropes where they may be blown in to areas making retrieval difficult
<input type="checkbox"/>	<b>Lightning</b>	<ul style="list-style-type: none"> <li>Possible electrocution due to lightning strike, loss of consciousness or life</li> <li>Rope-access equipment may provide a pathway to the operative for electrical strikes</li> </ul>	<input type="checkbox"/> Stop work when lightning threatens
<input type="checkbox"/>	<b>Dimly lit or night work</b>	<ul style="list-style-type: none"> <li>Sharp or protruding objects (metal, nails, bolts, etc.) may not be visible to moving operatives, drowsiness of employees</li> </ul>	<input type="checkbox"/> Provide adequate lighting: area lighting and/or head-and hand-lamps <input type="checkbox"/> Provide spare batteries, light sources, and bulbs
<input type="checkbox"/>	<b>Dust</b>	<ul style="list-style-type: none"> <li>Difficulty in breathing, possible allergic reaction</li> <li>Possible long-term exposure hazard</li> </ul>	<input type="checkbox"/> Provide adequate engineering controls <input type="checkbox"/> Provide PPE where engineering controls not possible or impractical
<input type="checkbox"/>	<b>Chemical exposure</b>	<ul style="list-style-type: none"> <li>Difficulty in breathing, dizziness, unconsciousness</li> <li>Chemical burns to skin, eyes, internal organs</li> </ul>	<input type="checkbox"/> Workers must have MSDS on site for all chemicals used in work <input type="checkbox"/> Proper PPE and engineering controls must be in place <input type="checkbox"/> Respirators must be the correct type for the exposure
<input type="checkbox"/>	<b>Confined space entry</b>	<ul style="list-style-type: none"> <li>Work areas may contain toxic gases or insufficient oxygen levels for work.</li> <li>Space may have restricted entry/exit making access difficult,</li> </ul>	<input type="checkbox"/> Follow confined space procedures <input type="checkbox"/> Toxic rescue plan required and in force prior to entry
<input type="checkbox"/>	<b>High-noise area</b>	<ul style="list-style-type: none"> <li>Permanent or temporary damage to hearing</li> <li>Difficult Communications</li> <li>High-noise levels may mask warning buzzers or other alert sounds</li> </ul>	<input type="checkbox"/> Hearing protection required, in extremely loud environments (+120 dBA), multiple types of protection may be necessary. <input type="checkbox"/> Agree on hand signals before work starts <input type="checkbox"/> Workers may be equipped with sound-isolating hearing protection for radios.
<input type="checkbox"/>	<b>Insect or animal bites or stings</b>	<ul style="list-style-type: none"> <li>Possible injury or incapacitation of personnel depending on severity of bite or venom</li> </ul>	<input type="checkbox"/> Careful access into areas where spiders, snakes, scorpions, or other creatures may reside. <input type="checkbox"/> Use of gloves at all times, equip first aid kit with medical supplies appropriate for bites and stings.
<input type="checkbox"/>	<b>Vehicular</b>	<ul style="list-style-type: none"> <li>Possible impact or crushing injury</li> </ul>	<input type="checkbox"/> Careful demarcation of access and hazard zones, <input type="checkbox"/> Use flags, signs, flag persons, lighting as needed

	Condition	Description of Hazards		Control Measures
	Traffic		<input type="checkbox"/>	Provide high-visibility clothing for personnel
<input type="checkbox"/>	Bird & Animal Feces	<ul style="list-style-type: none"> <li>Possible inhalation of disease carried by feces</li> </ul>	<input type="checkbox"/>	Workers may need to wear protective gloves or respirators.

### Post Job Debrief

Date/Time Completed		Debrief Prepared by:	
Safety Considerations	Were adequate safety measures taken to insure the safety of personnel and public? Note any additional safety measure taken or recommended.		
Anchorage Used /Special Techniques	Describe the anchorage set-up used and any special techniques used		
Near Miss or Accidents	Describe any near misses or accidents. If none, write "none". Attach additional pages if necessary.		

## **USBR Rope Access Technician Initial Training Syllabus**

Following the course and successful completion of the field evaluation the technician should be able to:

- inspect his/her own personal rope access equipment and safety system
- perform a variety of maneuvers on rope comfortably
- assist in rigging and non-standard operations, under the guidance of a more experienced and trained technician
- complete a rescue involving descent or lowering and have a basic understanding of hauling systems.

### **Safety Standards and Documentation**

- Overview of USBR Guidelines and relevant US legislation and Standards
- Qualifications and responsibilities required of each team member
- Overview of various methods of access and hierarchy of risk
- Documentation including experience logbooks, equipment logs, and job hazard analysis (rope access permit)
- Standard safety checks
- Proper and effective communication between team members
- Understanding of Access, Hazard, and Safe Zones
- Care, Inspection, Use, and Limitations of Equipment
  - Personal protective equipment (PPE)
  - Carabiners and other connectors
  - Descenders, rope grabs and ascenders
  - Dynamic and static ropes
  - Harness
  - Slings and straps
  - Belay and back-up devices

### **Systems Analysis and Rigging**

- Knots: Figure 8 and 9, Double-figure eight, Butterfly, Prusik, Barrel Knot, Double Fisherman's
- Overview of basic rigging skills (single-point and simple two-point anchor) taking into account fall line, area of work, and terrain
- Introduction to analysis of rope access systems, including fall factors, impact forces, and resultant forces

### **Technical Rope Access Skills**

- Ascent/Descent and negotiating edges on rope
- Changeovers from ascent/descent and vice versa
- Passing knots, deviations, and intermediate anchors (re-belay)
- Rope to rope transfer
- Horizontal aid climbing: point to point and shuffling
- Structure climbing: Overview of horizontal/vertical lifelines, shock absorbing Y-lanyards, and other standard fall protection systems

### **Rescue**

- Discuss risk management, rescue protocol, and casualty management
- Introduction to simple mechanical advantage systems utilizing standard equipment and pulley systems
- Single person rescue pick-off of a descending casualty
- Introduction of basic retrieval using hauling and lowering systems

## **USBR Rope Access Technician Advanced Training Syllabus**

Following the course and successful completion of the evaluation the technician should be able to:

- evaluate the safety of rope access equipment and systems
- perform basic and advanced access techniques
- understand fundamental system dynamics
- establish complex anchor systems
- efficiently perform standard rescue procedures using mechanical advantage and lowering systems

### **Safety Standards and Documentation**

- Review of Rope Access Guidelines and relevant US legislation
- Qualifications and responsibilities required of each level of Rope Access Technician
- Review of various methods of access and hierarchy of risk
- Documentation including experience logbooks, equipment logs, and job hazard analysis (rope access permit)
- Consistent safety checks
- Insuring proper and effective communication between team members
- Establishing Access, Hazard, and Safe Zones
- Care, Inspection, Use, and Limitations of Equipment

### **Systems Analysis and Rigging**

- Knots: Figure 8 and 9, Double-figure eight, Butterfly, Prusik, Barrel Knot, Double Fisherman's, Clove Hitch, Muenster (Italian) Hitch w/mule knot, Water (Tape) knot, and tensionless hitch
- Practice advanced rigging skills (single-point and load sharing/distributing multi-point anchoring) taking into account fall line, rigging angles, area of work, and terrain
- Application of redirect and rebelay anchors
- Pre-rigging anchors for lowering or pull-through
- Discussion of anchor installation and testing
- Analysis of rope access systems, including fall factors, impact forces, and resultant forces

### **Technical Rope Access Skills**

- Ascent/Descent and change-overs
- Passing knots, deviations, and intermediate anchors (re-belay)
- Rope to rope transfer
- Horizontal aid climbing: point to point and shuffling
- Structure climbing: Overview of horizontal/vertical lifelines, shock absorbing Y-lanyards, and other standard fall protection systems

### **Rescue**

- Risk management, rescue protocol, and casualty management
- Extensive practice with mechanical advantage systems utilizing standard equipment and pulley systems
- Breaking into tensioned fixed ropes with haul systems
- Converting between lowering and hauling systems
- Single person rescue pick-off of a descending and ascending casualty
- Descending with casualty past obstructions (redirect, knots, anchors)







## Resource List

### Books:

Reclamation Safety and Health Standards, 2001, U.S. Department of the Interior, Bureau of Reclamation, Denver, Colorado, 390 p.

CMC Rope Rescue Manual, 1998, edited by James A. Frank, CMC Rescue, Inc., Santa Barbara, California, 208p.

The North American Working at Height Handbook, 2004, Forrest, A., North Sea Lifting Limited, 158p.

The American Rigging & Lifting Handbook, 2001, Forrest, A., North Sea Lifting Limited, 188 p.

On Rope, 1997, Padgett, A., Smith, B., 2<sup>nd</sup> edition, Huntsville, AL, National Speleological Society

### Web Pages:

Society of Professional Rope Access Technicians (SPRAT):  
<http://www.sprat.org>

Industrial Rope Access Trade Association (IRATA):  
<http://www.irata.org>

Cordage Institute web page: [www.ropecord.com](http://www.ropecord.com)

Occupational Safety and Health Administration (OSHA) web page:  
<http://www.osha.gov>

Health and Safety Executive (HSE) (the United Kingdom's OSHA equivalent) web page: <http://www.hse.gov.uk>

# GUIDELINES FOR ROPE ACCESS



# GUIDELINES FOR ROPE ACCESS



# GUIDELINES FOR ROPE ACCESS



# GUIDELINES FOR ROPE ACCESS



# GUIDELINES FOR ROPE ACCESS



# GUIDELINES FOR ROPE ACCESS

